

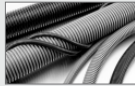















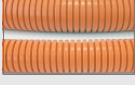
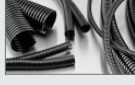



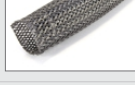













Distributed by:
Eastern Connector Specialty
Toll Free: 1-877-788-0888
Direct: 1-860-355-8100
sales@easternconnector.com

WIRE & CABLE PROTECTION
CATALOG

2013 VERSION 1.0

	LHT Highly Flexible, Heavy Duty Conduit (PA12)	Page 12		PME Very Flexible, Medium Duty Conduit (PA6)	Page 13
	LHR Highly Flexible, Automation Conduit (PA12)	Page 14		UCV Very Flexible, UL Listed Conduit (PA6)	Page 15
	CHS Flexible, Heavy wall Conduit (PA6)	Page 16		VMS Polyvinylidene Fluoride Conduit	Page 17
	CMP Polyvinylidene Fluoride Connectors	Page 17		PMB External Metal Braid Covered Conduit	Page 18
	TMF Thermoplastic Covered Conduit	Page 19		PHG Flexible, Medium-Heavy Duty Conduit	Page 20
	HYB Highly Flexible, Heavy Duty Conduit (PA12)	Page 21		PMD Divisible Conduit (PA6)	Page 22
	NMD Polypropylene Divisible Conduit	Page 22		PLF Flexible, Light wall, Slit conduit (PA6)	Page 23
	NLF Polypropylene Flexible, Light wall, Slit conduit	Page 23		MPT Polyethylene Braided Sleeve	Page 24
	MNH Flat Filaments Sleeve	Page 24		MDP Tubular Weave Sleeve	Page 24
	MFG Resin Coated Fiberglass	Page 24		MFW Braided Wrap Sleeve	Page 25
	MFR Flame Inhibitor Wrap	Page 25		MDW Ballistic Nylon Wrap	Page 25
	MWW Fiberglass Wrap Sleeve	Page 25		KMS Straight, Male Thread, Polyamide Connector	Page 26
	KME 90° Elbow, Male Thread, Polyamide Connector	Page 28		KMF 45° Elbow, Male Thread, Polyamide Connector	Page 30
	KDS Divisible Two Part Fitting System	Page 32		LMSS Straight Swivel, Male Metal Thread, Polyamide Connector	Page 33
	LMSE 90° Elbow Swivel, Male Metal Thread, Polyamide Connector	Page 34		LMSF 45° Elbow Swivel, Male Metal Thread, Polyamide Connector	Page 35
	KRS Strain Relief, Male Thread, Polyamide Connector	Page 36		BRS Strain Relief, Male Metal Thread, Polyamide Connector	Page 38
	KFS Straight Female Thread, Polyamide Connector (MIL-DTL-5015 / VG-95234)	Page 40		KFAS Straight Female Thread, Polyamide Connector for AMP series	Page 40
	KFBS Straight Female Thread Connector for ITT Cannon Trident	Page 41		CFS Straight Female Thread Connector for Electronic Sensors	Page 41

	KFS Straight, Female PG Thread, Polyamide Connector	Page 42		BFS Straight, Female Metal PG Thread, Polyamide Connector	Page 42
	LFSS Straight Swivel, Female Metal Thread, Polyamide Connector	Page 43		LFSE 90° Elbow Swivel, Female Metal Thread, Polyamide Connector	Page 44
	LFSF 45° Elbow Swivel, Female Metal Thread, Polyamide Connector	Page 45		LFSS Straight Swivel, Metal UNEF Thread, Polyamide Connector	Page 46
	LFSS ES Straight, Female Metal UNEF Thread, Connector (MIL-DTL-5015 / VG-95234)	Page 47		LFASS Straight Swivel, Metal UNEF Thread, Connector (AMP)	Page 48
	LFBSS Straight Swivel, Metal UNEF Thread, Connector (ITT Cannon Trident)	Page 48		LFSE 90° Elbow Swivel, Metal UNEF Thread, Polyamide Connector	Page 49
	LFSF 45° Elbow Swivel, Metal UNEF Thread, Polyamide Connector	Page 50		EMFS Straight, Female Metal Thread, EMI Connector	Page 51
	EMFS ES Straight, Female Metal Thread, EMI Connector (MIL-DTL-5015 / VG-95234)	Page 52		EMMS Straight, Male Metal Thread, EMI Connector	Page 53
	Custom Transition & Conversion Adapters	Page 55		MIL-DTL-5015 / VG-95234 Circular Connectors, Standard Bayonet Ring (INDOORS)	Page 56
	MIL-DTL-5015 / VG-95234 Circular Connectors, Rubber Coated Bayonet Ring (OUTDOORS)	Page 56		MIL-DTL-5015 / VG-95234 Circular Connectors, Short Rubber Coated Connector (OUTDOORS)	Page 56
	MIL-DTL-5015 / VG-95234 Circular Connectors, Front Panel Mounting Receptacle	Page 57		MIL-DTL-5015 / VG-95234 Circular Connectors, Rear Panel Mounting Receptacle	Page 57
	MIL-DTL-5015 / VG-95234 Circular Connectors, Jam Nut Receptacle	Page 57		MIL-DTL-5015 / VG-95234 Circular Connectors, Inline Receptacle	Page 57
	TRAC Data Connectors	Page 58		GTM12 Connector for field assembling	Page 59
	BCU Tinned Copper Flat Braid	Page 60		B04 Stainless Steel Braid	Page 60
	SLR Seamless Ring Lugs	Page 61		GSF Highly Flexible Grounding Straps	Page 62
	GSR Air Cooled High Current Grounding Straps	Page 63		KST T Splice Connector	Page 64
	KDT T Divisible Splice Connector	Page 64		KSY Y Splice Connector	Page 65
	KDY Y Divisible Splice Connector	Page 65		KSS Conduit Splice Connector	Page 66
	KTR Conduit Reducer	Page 66		KPCN Conduit Splice Connector to Electric Pipes	Page 67

	KLE 90° Elbow, Polyamide Flange Connector	Page 68		KLF 45° Elbow, Polyamide Flange Connector	Page 69
	KLE 90° Jumbo Elbow, Polyamide Flange Connector	Page 70		KLS Jumbo, Polyamide Flange Connector	Page 70
	KGXJ Cable Gland, Extended, Polyamide	Page 71		KGJ Cable Gland, Polyamide	Page 72
	NGJ Cable Gland, Metal	Page 74		KC1 One-piece Tube Clamp with Integrated Safety Clip	Page 76
	TCR Rail for system Support	Page 76		KCD Divisible Tubing Clamp	Page 77
	KC6 One-piece Tube Clamp with Integrated Fixed Base	Page 77		KCB System Support for Stacking	Page 78
	KCR One-Piece System Support	Page 78		CC Galvanized Steel Tube Clamp	Page 79
	CU Galvanized Steel Tube Clamp	Page 79		KRAS Abrasion Protection Sleeve	Page 80
	KRIS Conduit Internal Support Sleeve	Page 80		KR SR/SS Reducer with Strain-relief or Slide	Page 81
	KRSC Grommet Strain Relief Insert	Page 81		KR SRC/SSC Strain-relief or Slide Insert	Page 82
	SWI-BASE-23 Swivel Base for Tube Clamp	Page 82		KR SB Swivel Base For Tube Clamp	Page 83
	SWI-BASE ROBOT2 Swivel Base for KR-C Clamp	Page 83		KRJS Ball Joint Sleeve	Page 84
	KRJT Ball Joint Termination	Page 84		KRC Automation Tube Clamp	Page 85
	NGP-95-1-X1 Automation Tube Clamp	Page 85		KAS Conduit Protection Sleeve	Page 86
	AC Sealing Caps	Page 86		OR Sealing Rings	Page 87
	GAG Sealing Flat Gaskets	Page 88		OT Grip Lock Universal Tool	Page 89
	MGL-CUT Grip Lock Conduit Cutting Tool	Page 89		ST Split Conduit Insertion Tool	Page 89
	KLN Polyamide Lock Nuts	Page 90		BLN Metal Lock Nuts	Page 91



THE COMPANY...Who we are

Moltec International is North America's premier developer and provider of wire and cable protection systems.

Passionate about providing our customers with solutions that surpass expectations, we combine the outstanding performance characteristics and diversity of European made wire and cable protection products with innovative in-house design, engineering and manufacture of custom adapters and specialty fittings.

Our line of comprehensive wire and cable protection solutions includes a broad range of specially modified corrugated nylon conduit to meet various industry-specific needs. Accompanying our conduit is a diverse selection of fittings, system supports and accessories. We further expand our solution breadth and depth by pairing our design and engineering services with our manufacturing capabilities to deliver standard or custom adapters, specialty connectors, wire-cable harnesses and electrical assemblies.

A commitment to developing unique customer-centric solutions of the highest quality and workmanship is the cornerstone for our success.

DESIGN & DEVELOPMENT...Engineering Services

As an essential part of Moltec's value-added integration solutions, our engineering services team works closely with customers to first, identify the fundamental need and second, define the project parameters. Once the project details are finalized, our goal is to evaluate and optimize product functionality and minimize manufacturing costs. Throughout the product development life cycle, our skilled engineers provide innovative solutions using advanced software and modern techniques.

Product Development

Years of industry experience across a wide and diverse spectrum of businesses prepares our engineers for designing solutions that shorten product development time and are cost effective. Working with cross functional teams including Industrial Design, Mechanical and Electrical Engineers, Moltec delivers solutions that are rooted in practical applications and guided by project management expertise. Our customers keep on coming back year after year for our support and follow through on:

- *Conceptual design*
- *Industrial, electrical and mechanical engineering*
- *CAD modeling and detailing*
- *Simulation, analysis and prototyping*
- *Product testing and manufacturing*

Consulting

The Moltec consulting team offers forward-thinking insight and knowledge in order to break through any design and operational challenges. We provide design engineering services to a diverse clientele, ranging from medium sized, single-product companies to multinational, multi product corporations. Many of our customers are Global 1000 companies who use our services as a management tool to balance their variable workloads.

Project Management

Project management plays a key role in combining our services to deliver a solution that exceeds our clients' goals. We do this by thoroughly planning, coordinating, securing, managing, and controlling resources in a proficient and professional manner, all

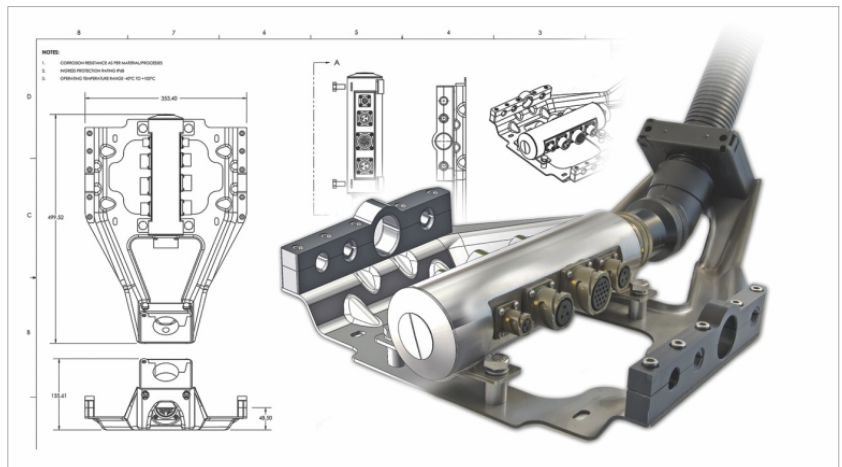

within a customer specified time frame and budget guidelines. Using a seamless approach, the Moltec team members are involved in all stages of the development process from concept to finished product. The end result is an uncompromising product that retains the essence of the original vision.

Benefits

- Access to Licensed Professional Engineers
- Thorough Understanding and Compliance to Industry Standards and Codes
- Comprehensive Library of Drawings Available
- Product Integration with Customer Designs
- Full System Layout



MANUFACTURING SERVICES...Volume Production or Custom Manufacturing, Moltec Machine Delivers

Whether requirements are large or small, complex or simple, Moltec Machine has the experience and skills to get the job done right! We specialize in producing custom fittings and adapters as well as complex profiled components and assemblies in a timely and environmentally responsible manner.

Moltec Machine has the capability to manufacture products from a variety of materials including Plastics, Aluminum, Steel, Brass and more. Moltec Machine has a reputation for producing high quality, cost effective products while being flexible to time constraints. Our team-oriented operation is committed to exceeding customer's expectations for both quality and on-time delivery. Working with our in-house design engineering team and technical support personnel, we seamlessly take a product from conception to prototype development, then on through to production manufacturing.

Machine Shop Capabilities

- Haas VF3 CNC Mill: - 5 Axis rotary table, 24 tool magazine, Jergens sub plate and 2 Chic quick changeover vises (10,000 rpm)
- Haas TL-25 CNC Sub-Spindle lathes: - 30-hp (22kw), 3400 rpm main-spindle with 3" through hole capability
- Haas TL-15 CNC Sub-Spindle Lathes: - 30-hp (22kw), 5000 rpm main spindle with 2" through hole capability
- Haas GT-20 Lathe, single spindle
- Plus other precision machine shop equipment



Plating

Application specific finishing is offered through the plating and anodizing options that improve the overall adapter characteristics and meet our customers' needs, such as:

- | | |
|------------------------|------------------------------|
| ◦ Aesthetics | ◦ Prevent galling |
| ◦ Corrosion Inhibition | ◦ Alter conductivity |
| ◦ Increase hardness | ◦ Radiation shielding |
| ◦ Improve Durability | ◦ Improve soldering ability |
| ◦ Reduce friction | ◦ Improve paint adhesiveness |

Benefits

- ROHS compliant
- High quality, precision machined parts
- Low minimums

CUSTOM ASSEMBLIES...Made-To-Fit Custom Solutions!

We provide our customers with high quality conduit, fittings and accessories that represent over 9,000 items of stock. Our GRIP LOCK products satisfy an array of options for managing and protecting wires and cables and we don't stop there. An integral part of Moltec's services goes beyond simple off-the-shelf items, and that is our ability to deliver full custom solutions that meet and exceed our customers' stringent requirements. Our project management team ensures a timely and cost effective integration of our engineering, manufacturing and production services to create the highest grade of custom solutions, ranging from simple adapters to complex fully-wired cable harness assemblies.

Moltec custom designed and engineered harness solutions are employed by a growing cross section of original equipment manufacturers looking for high quality wire and cable harnesses. Moltec delivers a flexible and dependable watertight solution that offers excellent oil, grease and chemical resistance as well as resistance to temperature, weathering and abrasion. The harnesses are designed and built with high quality conduit and vibration proof connections as well as with metal shielding and custom terminations that provide protection against electromagnetic interference where required.

All custom fittings and harnesses are designed, assembled and tested in-house and delivered as an easy out-of-the-box Plug & Play System. These custom fittings and harnesses can also be supplied in kit form accompanied by easy to follow installation instructions. Our systems comply with the highest International smoke, flame and toxicity requirements as well as delivering:

- *Safe and reliable; easy to install*
- *UL Listed, UL Recognized, CSA/US Approved and ETL Cert.*
- *Excellent self-extinguishing properties*
- *Excellent weathering, UV and temperature resistance*
- *High impact strength even at low temperatures*
- *High compression strength (peak load)*
- *Ingress protection up to IP68 (NEMA 6P)*
- *Vibration proof connections*
- *ROHS and REACH compliant*
- *Excellent chemical resistance to fuels, mineral oils, fats, alkalis, weak acids and bases*
- *Free of halogens, phosphor and cadmium*

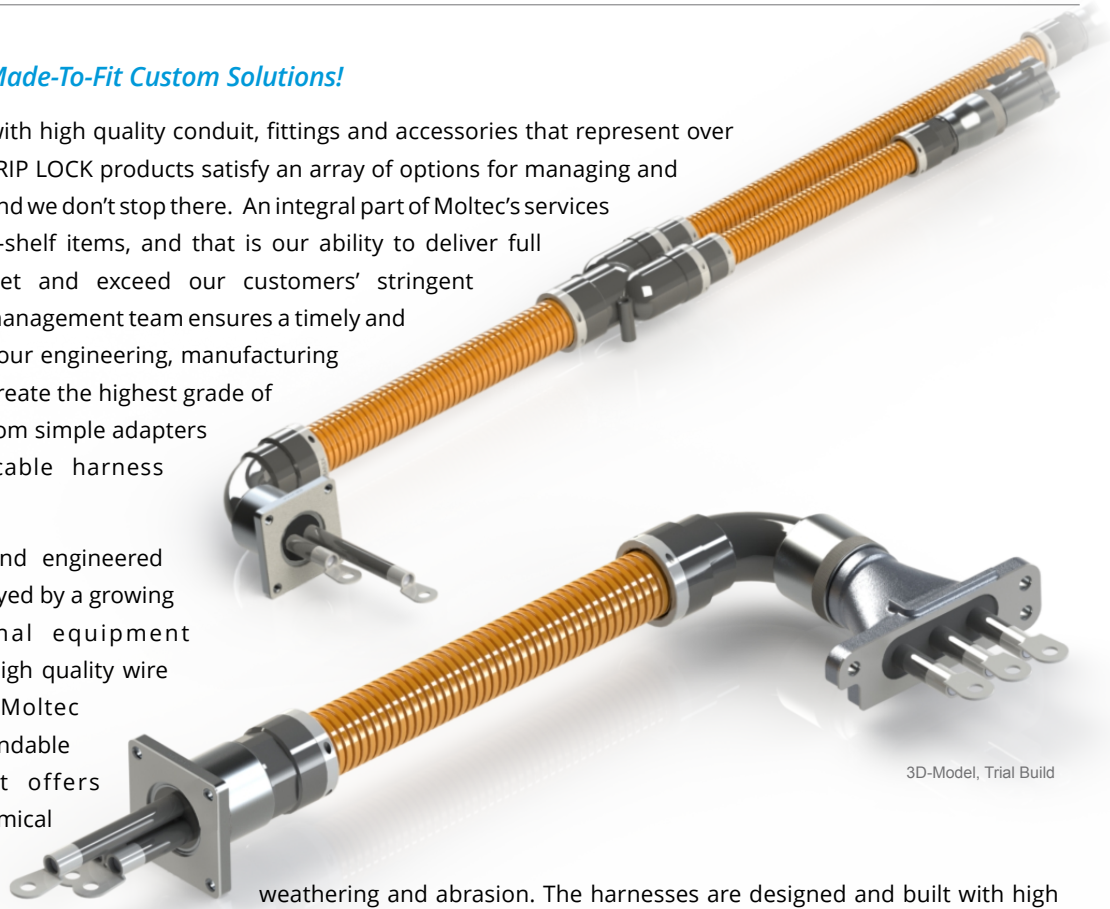

3D-Model, Trial Build

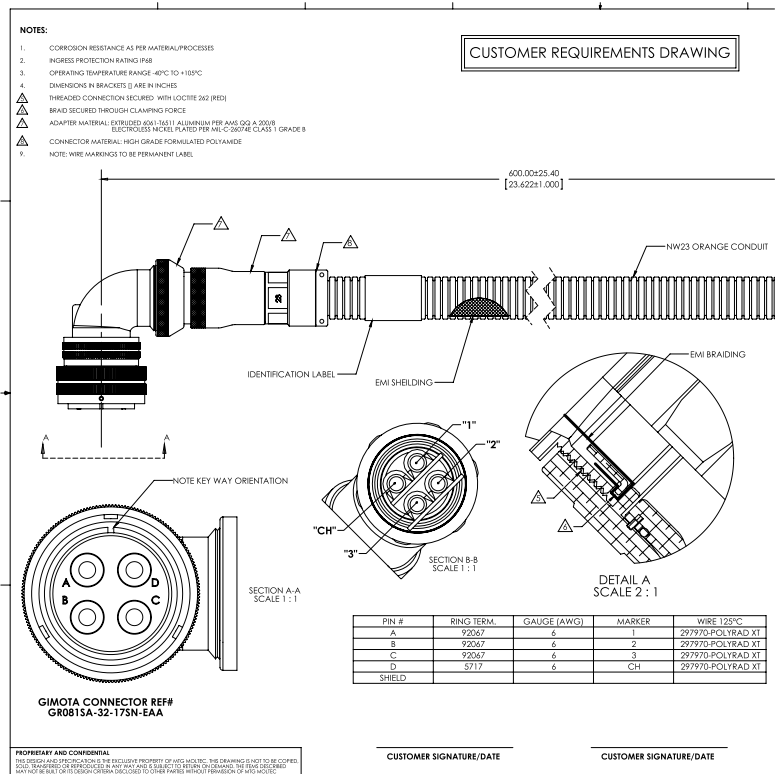

Wind Energy

Moltec Windpower Products essentially designs, engineers and fabricates the industry's first Pre-engineered, Pre-assembled, and Pre-tested, modular lighting and electrical utility service systems for wind turbine tower and nacelle applications.

The system known as Quik-Fit II has been successfully installed into a wide range of tower designs for the North American market.



This truly modular system provides a single utility trunk line interconnecting harness, which carries two (2) circuits through the tower length, one for lighting and one for power outlets. Its non-metallic, corrugated, watertight design is constructed of a specially modified polyamide compound that is rugged yet very flexible, and exceeds all agency requirements for smoke, flame, and toxicity ratings, operating down to -40°C [-40°F]. The Quik-Fit II system is ETL Listed, and all electrical materials and components used in the construction are UL Listed or Recognized and/or CSA/US approved. These trunk-

line interconnect harnesses allow for placement of our numerous light fixtures, power utility boxes, switches, and power input assemblies (all called devices) wherever, and whenever the tower or nacelle layout requires.

The simplicity and ease of installation of the Quik-Fit II system comes from the design of our special connectors used on all trunk-line interconnects and devices. The connectors are constructed with quarter-turn fastening, anti-back off, and vibration proof features. No electrical wiring labor or tools are required for installations. Simply twist-and-lock the keyed mating connectors and the system is built, and of course this installation can be done without specialized and costly skilled labor. Moltec provides simple to follow written and illustrated instructions with the system which are available in several languages. Moltec can provide engineering and design-in support services at very reasonable cost and we can do your entire layout for you in CAD drawings and/or 3-D modeling formats. You can also choose to have these modular components kitted by tower section which makes the purchasing, material handling, and of course, the installation that much faster. When the towers arrive at the construction site even more savings will be had as the tower installation contractor need only make one fast and simple twist-and-lock connection between tower sections. In and out in no time, and the power outlets and the lighting can operate in minutes to assist in the tower construction process.



Solar Installations

The Solar EZ Connect system was developed in collaboration with developers and installation contractors. The system is comprised of a fully wired harness that is ready to be installed right out of the box substantially reducing the high costs associated with hand assembly and routing of wiring in the field. The multiple strings of multi-panel arrays are easily assembled and run to the combiner boxes eliminating the need for certified labor.

Solar EZ Connect is designed and manufactured to the specifications of every project layout with no limit to the size or configuration. The system is comprised of specialized wire protection products that offer flexibility, durability, and watertight construction with high resistance to UV exposure and weathering as well as damage from rodents. The system utilizes industry standard solar cable connectors for interconnection to the mating input/output cable connectors from each multi-panel string. The Moltec system is constructed with UL approved, UR Recognized, and CSA certified electrical components. Every system is electrically and mechanically tested to ensure the highest level of quality, installation success, and elevated operational performance. Wiring errors in the field and the high cost associated with re-work and project start-up delays are virtually eliminated.

Transit Related

Our standard and custom GRIP LOCK solutions deliver proven quality and long service life for use in the toughest environments in and around rail applications that include areas underneath railcars, on railcar rooftop, inter-car jumpers, couplers and bogies. Grip Lock products comply with the highest international flame, smoke and toxicity standards making them ideal for protecting wires and cables in passenger zones such as people movers.

Our heavy grade conduits are flexible yet very durable and exhibit outstanding resistance to UV and weathering at low and high temperatures, exceptional mechanical resistance and impact strength delivering optimal performance in both static and dynamic outdoor applications. The IP68 (NEMA 6P) fittings make for a smooth ride with shock and vibration proof connections to the conduit.

Grip Lock solutions are also used to ensure safe and reliable functioning of track related wayside applications. From the ballast stones to the highest

signal light, our products protect wires and cables from the harmful effects of the environment as well as the daily wear and tear typical in wayside installations. Moltec carries thousands of items that match the specification needs for signal installations, controls systems, monitoring and information systems, and power supplies to high voltage rails.



General Machines

Machine manufacturers make up a very diverse and specialized industry. Each manufacturer designs machines to function at peak performance every time in order to meet customer needs with packaging, printing, and processing machinery, filling and loading systems, heating and ventilation, and conveyor systems to name a few. Whether you are building a one-off or a series of machines, GRIP LOCK wire and cable protection solutions are the answer.

Our GRIP LOCK products are manufactured from specially formulated polyamide as well as other durable materials to effectively fill the many needs of unique applications across the industries we serve. Various conduit styles are available, each delivering distinct attributes such as increased mechanical strength, flexibility, broad temperature ranges and UV resistance. The conduit is accompanied by a full range of fittings, system supports, and accessories insuring that our customers receive complete solutions. The fittings are available in different body configurations, sizes and thread types. Our fully sealed GRIP LOCK solutions protect the wires and cables on machines against potential stresses that include pull, compression, and impact, as well as abrasion and vibration. A dependable, safe, and easy connection between the conduit and fittings is achieved with our unique integrated locking element for a secure and aesthetically pleasing termination.



Moltec provides machine builders with comprehensive solutions for the protection of wires and cables for a multitude of machine types. Our product depth and breadth insures a quality solution can be easily found for any standard or custom project.

Robotics & Automation

The robotic industry is growing at a faster rate than ever with more and more companies implementing automated processes to improve efficiency and productivity. Robots and automated machines must function at peak speeds while simultaneously delivering precise accuracy. In order to prevent expensive down time our custom fitted Grip Lock dress package solutions install



quickly and easily to get your robots up and running in no time. Moltec offers a range of robotic products that have been designed to protect cables and leads from damage in extreme automation and robotic installations. Our Grip Lock robotic conduit, clamps, swivels and components protect the steer and lead elements against abrasion, push/pull, bending and torsion forces and significantly increases the life cycle of the installation.

Our robotic Polyamide 12 conduit is specially manufactured to provide high quality and long service life in motion intensive applications. It is extremely flexible and can withstand up to 10,000,000 reverse bend cycles. Whether you require a dress package for a J6 robot or are building an automated dispensing machine, our comprehensive Grip Lock solutions offer optimal installation along moving elements and reduce the amount of stress and abuse endured by robotic cable packages.

Our robotic Polyamide 12 conduit is specially manufactured to provide high quality and long service life in motion intensive applications. It is extremely

flexible and can withstand up to 10,000,000 reverse bend cycles. Whether you require a dress package for a J6 robot or are building an automated dispensing machine, our comprehensive Grip Lock solutions offer optimal installation along moving elements and reduce the amount of stress and abuse endured by robotic cable packages.

Hybrid Vehicles

Over the past 32 years, Moltec has grown to become one of the industry's leading sources for wire and cable interface solutions as well as engineering and fabrication of specialized wire and cable harness assemblies for extreme applications in various market sectors.



Moltec's flexible, non-metallic conduit and back-shell systems in conjunction with our specialty metal fittings are combined with the finest tinned copper braid to make reliable, lightweight, and vibration-proof plug & play harness assemblies. The fully shielded EMI interconnection system provides optical coverage of over 95% featuring 360 degree contact assuring a very low resistance to ground. Our harnesses provide the protection and durability necessary in extreme applications for the markets we serve.

It is imperative that wiring protection systems in the hybrid industry do not exceed weight restrictions, yet remain durable enough to withstand the extreme conditions found in areas such as underneath, between and on top of the vehicles. Moltec's success in the Hybrid Drive market is a result of our long standing industry involvement, technical expertise, outstanding customer service, and uncompromising product quality.

Our Hybrid Harnesses have been re-engineered and re-designed to reduce manufacturing and assembly time, reduce the number of components, and effectively reduce the weight of the harness. These modifications have significantly cut the harness costs without compromising the fit, performance, or quality and we are pleased to pass the savings onto our customers!

General Contracting (UL-LISTED Material)

Safety is a top priority in virtually all business sectors today. The UL Listed certification is an unbiased safety assurance which confirms that products bearing the UL mark have been tested and comply with the National Electrical Code (NEC) and the Canadian Electrical Code (CEC). The Grip Lock UL Listed wire and cable protection solutions offer a safe and reliable connection and are quick and easy to install. The specially formulated conduit delivers very good flexibility, impact and fatigue strength even at low temperatures and dry conditions. Our fittings feature a unique integrated locking ring that locks onto the conduit using a hand held tool, minimizing the risk of vandalism or unintended disconnection. In addition to the UL listing, our system also carries other major industry certifications and has been specially developed to meet industry specifications in a wide range of electrical application areas.



The vibration-proof solutions provide extended life in demanding environments by protecting against elements and hazards that can otherwise damage wires and cables, resulting in down time and costly repairs. Exhibiting excellent mechanical properties to withstand impact, compression and abrasion stresses our system also displays excellent resilience against various oils, greases and chemicals. GRIP LOCK products have been designed to allow for optimal management of wires and cables on static and dynamic installations and in both internal and external applications in order to extend the operational life of all forms of electrical systems.

Mining & Heavy Equipment

Heavy-duty vehicles and machinery are used for the extraction of valuable minerals in the mining industry. Our research and design activities are firmly focused on providing our customers with solutions that result in reliable and extended service life from their equipment. Moltec provides an array of wire and cable protection solutions that are specially designed for use in mining applications. Our Grip Lock mining products include conduit, fittings, system supports, and custom designed solutions to protect wiring and cables from harmful elements such as extreme weather conditions, chemical agents, liquid and dust penetration, as well as inevitable impact, compression and abrasion.



The fittings are offered in nylon and metal Metric, PG, NPT, Gas and UNEF threads. The heavy-duty conduit is durable and exhibits outstanding self-extinguishing characteristics and minimal development of smoke and gas. It is offered in a green colour for easy identification of electrical cable systems in mining equipment. Various mounting and wire routing options are attained through the use of our system supports with T and Y splice fittings allowing for a complete and trim finish.

GRIP LOCK systems are designed to absorb the harsh environment associated with mining, assuring that all electrical wiring and cables remain dry and protected.

Conduit Reference Code

PME-FK12.50

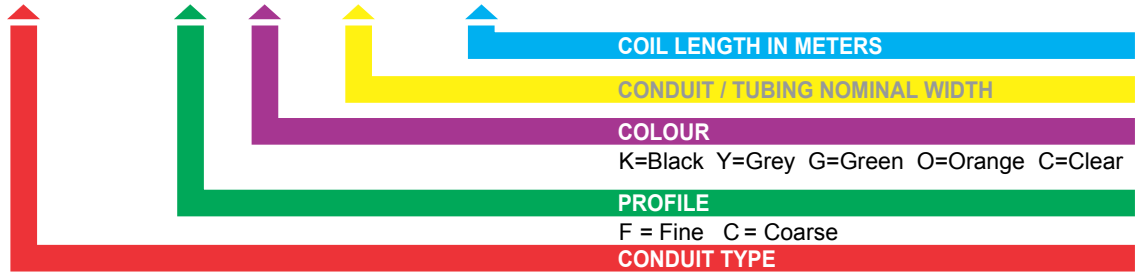

Connector Reference Code

K8-M-S-10M20

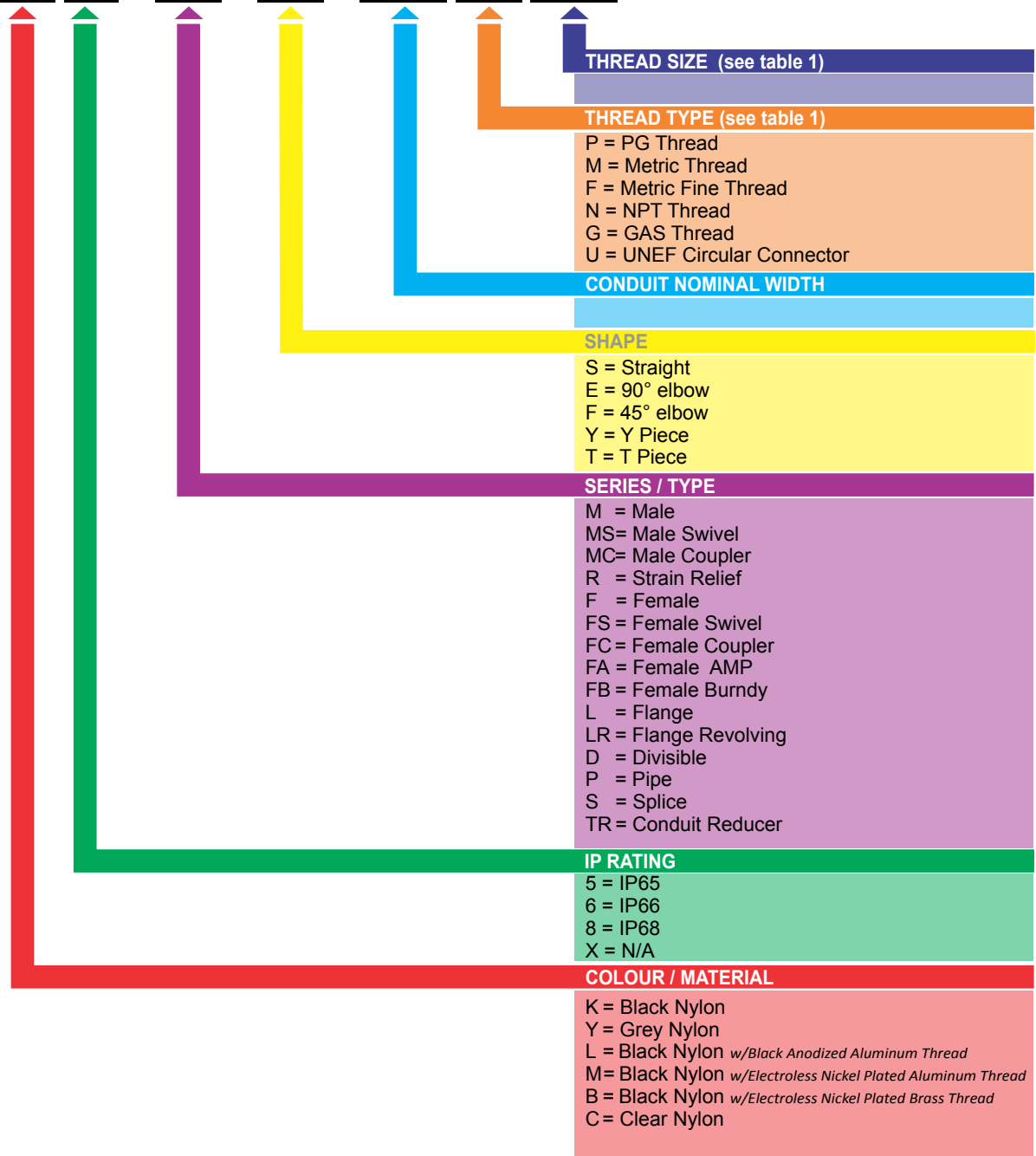
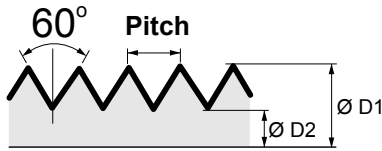
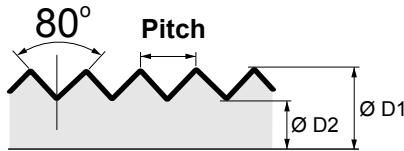

Table 1 Thread Codes

Thread Metric	Code	Thread PG	Code	Thread Gas	Code	Thread NPT	Code	Thread UNEF	Code	Thread UNEF	Code
M12x1.5	M12	PG07	P07	G 1/4"	G01	N 1/4"	N00	3/8-28 UNEF	U09	1 3/16-18 UNEF	U29
M16x1.5	M16	PG09	P09	G 3/8"	G01	N 3/8"	N01	7/16-28 UNEF	U10	1 1/4-18 UNEF	U30
M20x1.5	M20	PG11	P11	G 1/2"	G02	N 1/2"	N02	1/2-28 UNEF	U12	1 5/16-18 UNEF	U32
M25x1.5	M25	PG13.5	P13	G 3/4"	G04	N 3/4"	N04	9/16-24 UNEF	U13	1 3/8-18 UNEF	U34
M32x1.5	M32	PG16	P16	G 1"	G06	N 1"	N06	5/8-24 UNEF	U15	1 7/16-18 UNEF	U35
M40x1.5	M40	PG21	P21	G 1 1/4"	G07	N 1 1/4"	N07	11/16-24 UNEF	U16	1 5/8-18 UNEF	U40
M50x1.5	M50	PG29	P29	G 1 1/2"	G08	N 1 1/2"	N08	3/4-20 UNEF	U18	1 11/16-20 UN	U41
M63x1.5	M63	PG36	P36	G 2"	G09	N 2"	N09	13/16-20 UNEF	U20	1 3/4-18 UNS	U43
		PG42	P42	G 2 1/4"	G10	N 2 1/4"	N10	7/8-20 UNEF	U21	2-18 UNS	U50
M8x1.0	F08	PG48	P48	G 2 1/2"	G11	N 2 1/2"	N11	15/16-20 UNEF	U23	2 1/4-16 UN	U56
M12x1.0	F12							1-20 UNEF	U24	2 3/8-12 UN	U57
M18x1.0	F18							1 1/16-18 UNEF	U26	2 1/2-16 UN	U62
M30x1.0	F30										

EN 60423
Metric Thread

Metric	Pitch		ø D1		ø D2		Hole	
	mm	in	mm	in	mm	in	mm	in
12	1.50	0.06	12.00	0.47	10.50	0.41	12.50	0.49
16	1.50	0.06	16.00	0.63	14.50	0.57	16.50	0.65
20	1.50	0.06	20.00	0.79	18.50	0.73	20.50	0.81
25	1.50	0.06	25.00	0.98	23.50	0.93	25.50	1.00
32	1.50	0.06	32.00	1.26	30.50	1.20	32.50	1.28
40	1.50	0.06	40.00	1.57	38.50	1.52	40.50	1.59
50	1.50	0.06	50.00	1.97	48.50	1.91	50.50	1.99
63	1.50	0.06	63.00	2.48	61.50	2.42	63.50	2.50

DIN 40430
PG Thread

PG	Pitch		ø D1		ø D2		Hole	
	mm	in	mm	in	mm	in	mm	in
07	1.27	0.05	12.50	0.49	11.28	0.44	12.70	0.50
09	1.41	0.06	15.20	0.60	13.86	0.55	15.40	0.61
11	1.41	0.06	18.60	0.73	17.26	0.68	18.80	0.74
13	1.41	0.06	20.40	0.80	19.06	0.75	20.70	0.81
16	1.41	0.06	22.50	0.89	21.16	0.83	22.80	0.90
21	1.59	0.06	28.30	1.11	26.78	1.05	28.60	1.13
29	1.59	0.06	37.00	1.46	35.48	1.40	37.40	1.47
36	1.59	0.06	47.00	1.85	45.48	1.79	47.50	1.87
48	1.59	0.06	59.30	2.33	57.78	2.27	59.80	2.35

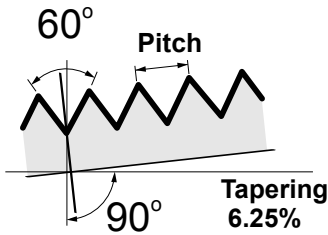
NSI B2.1 / ANSI B2.2
NPT (American Standard Taper Pipe Thread)

NPT	Pitch		Major ø		Hole	
	mm	in	mm	in	mm	in
1/4 "	1.41	0.06	13.62	0.54	13.90	0.55
3/8 "	1.41	0.06	17.06	0.67	17.40	0.69
1/2 "	1.81	0.07	21.22	0.84	21.60	0.85
3/4 "	1.81	0.07	26.57	1.05	26.90	1.06
1 "	2.21	0.09	33.23	1.31	33.70	1.33
1 1/4 "	2.21	0.09	41.98	1.65	42.40	1.67
1 1/2 "	2.21	0.09	48.05	1.89	48.50	1.91
2 "	2.21	0.09	60.09	2.37	60.60	2.39

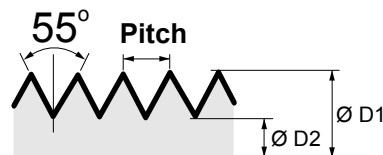
DIN 259 Bl. 3 ISO 228/1
GAS Pipe Thread

GAS	Pitch		ø D1		ø D2		Hole	
	mm	in	mm	in	mm	in	mm	in
1/4 "	1.34	0.05	13.16	0.52	11.45	0.45	13.40	0.53
3/8 "	1.34	0.05	16.66	0.66	14.95	0.59	17.00	0.67
1/2 "	1.81	0.07	20.96	0.83	18.63	0.73	21.30	0.84
3/4 "	1.81	0.07	26.44	1.04	24.12	0.95	26.80	1.06
1 "	2.31	0.09	33.25	1.31	30.29	1.19	33.70	1.33
1 1/4 "	2.31	0.09	41.91	1.65	38.95	1.53	42.40	1.67
1 1/2 "	2.31	0.09	47.80	1.88	44.85	1.77	48.31	1.90
2 "	2.31	0.09	59.61	2.35	56.66	2.23	60.20	2.37

Polyamide Chemical Resistance Chart

ASTM-Oil No.1 - 20°C	Resistant
ASTM-Oil No.2 - 20°C	Resistant
ASTM-Oil No.3 - 20°C	Resistant
Acetone	Resistant
Ammonia	Resistant
Animal oil and fats	Resistant
Arsenic acid, diluted	Resistant
Beer	Resistant
Benzene	Resistant
Benzene	Resistant
Borax, diluted	Resistant
Boron acid, diluted	Relatively Resistant
Calcium chloride, diluted	Not Resistant
Carbonic acid, diluted	Resistant
Cupric sulphate, diluted	Relatively Resistant
Cyanide, diluted	Resistant
Diesel oil	Resistant
Ethyl acetate	Resistant
Ethyl alcohol, diluted	Resistant
Fatty acid	Not Resistant
Ferric chloride, diluted	Relatively Resistant
Formic acid, diluted	Not Resistant
Fruit juices	Resistant
Fuel oil	Resistant
Glucose, diluted	Resistant
Glycerin, diluted	Resistant
Hydraulic oils	Resistant
Hydraulic oils based on phosphate	Resistant
Hydrochloric acid, diluted	Not Resistant
Hydrogen	Resistant
Kitchen salt, diluted	Resistant
Lactic acid, diluted	Relatively Resistant
Lead acetate, diluted	Relatively Resistant
Methyl-acetate	Resistant

Methyl-ethyl	Resistant
Methyl-ethyl ketone	Resistant
Methyl-wood alcohol	Relatively Resistant
Mineral oil without additions	Resistant
Nitric acid, diluted	Not Resistant
Nitro	Resistant
Oil and fats based on silicone	Resistant
Oil and fats, vegetable	Resistant
Ozone	Relatively Resistant
Perchlorated of ethylene	Relatively Resistant
Petroleum	Resistant
Phosphoric acid, diluted	Not Resistant
Potash lye, diluted	Resistant
Propane, fluid	Resistant
Sea water	Resistant
Silicic acid, diluted	Resistant
Skydrol	Resistant
Soap solution	Resistant
Soda lye	Resistant
Sodium chloride	Resistant
Spark-erosion liquids	Resistant
Starch, diluted	Resistant
Stearic acid	Resistant
Sulphurate of carbon	Resistant
Sulfuric acid, diluted	Not Resistant
Sulphuretted hydrogen	Resistant
Tartaric acid, diluted	Resistant
Toluene	Resistant
Transformer oil	Resistant
Trichloroethylene	Relatively Resistant
Turpentine	Resistant
Vinegar and acid of vinegar, diluted	Resistant
Xylol	Resistant
Zinc sulphate, diluted	Relatively Resistant

Ingress Protection (IP) According to EN 60529 / DIN 40050

IP68

Protection Against Dust



IP68

Protection Against Water



IP	Dust Protection	Water Protection
0	No protection No contact protection, no protection against solid particles and foreign bodies.	0 No protection No protection against water.
1	Protection against large foreign bodies Protection against large contact area with hands and foreign bodies $6 > 50\text{mm}$.	1 Protection against dripping water Protection against vertical water drops.
2	Protection against medium foreign bodies Protection against contact with fingers, protection against foreign bodies $6 > 12.5\text{mm}$.	2 Protection against inclined water drops Protection against inclined water drops (any angle up to 15° to vertical line).
3	Protection against small foreign bodies Protection against tool contact foreign bodies, wires or the like with $0 > 2.5\text{mm}$.	3 Protection against spray-water Protection against spray water from an angle of 60° to vertical line.
4	Protection against foreign grains Protection against tool contact, foreign bodies, wires or the like with $0 > 1\text{mm}$.	4 Protection against splash-water Protection against splash water from all directions.
5	Dust-protected Full contact protection. Protection against dust deposits inside.	5 Protection against water jets Protection against water jets from any angle.
6	Dust-tight Full contact protection. Protection against dust penetration.	6 Protection against powerful water jets Protection against powerful water jets from any angle.
		7 Protection against immersion Protection against water penetration 1m below the surface.
		8 Protection against submersion Protection against pressure water for an indefinite time (customer tailored).

Revolutionary Pre-installed Locking Ring

The Grip Lock system offers everything that one would expect from a conventional non-metallic wire and cable protection system highlighted with notable improvements and added benefits. The revolutionary preinstalled locking ring is the design feature that makes this system really stand out. Forget the frustration of losing locking components. The unique Grip Lock locking ring is integrated directly into the body of the fitting. It grips and locks the conduit in place and provides quality, safety and ease of assembly with a simple twist of the locking ring. Installation security is ensured with the use of a hand held tool. It makes assembly easy and prevents unintended disconnection or vandalism. The Grip Lock time-saving system delivers easy push-in connection of the conduit into the fittings. This allows for a quick and easy interface with all Grip Lock flexible non-metallic conduits.

IP66 / NEMA 4X



1 Make sure the locking collar is in the closed position. Push the conduit all the way into the fitting while twisting clockwise.



2 Pull back on the tubing slightly to ensure that the locking collar is fully engaged.



3 To re-open, simply use the **OT** tool to bring the locking collar to the open position.

IP68 / NEMA 6P



1 Fit the IP68 seal cap onto the end of the conduit, making sure to push it on completely.



2 Twist the locking collar to the open position. Push the conduit with applied seal cap all the way into the fitting.



3 Engage the system by twisting the locking collar to the closed position. For safety reasons, the locking collar will not engage if the seal cap is not fully installed.



4 Push the conduit deeper into the fitting to ensure an optimal connection.



5 To re-open, simply use the **OT** tool to bring the locking collar to the open position.

The main characteristic of this medium to heavy walled polyamide 12 conduit / tubing is the high fatigue strength while undergoing reverse bending stress. LHT is ideal for continuous dynamic use at very low temperatures. With its smoke, flame and toxicity certifications and excellent UV and weathering resistance, LHT is particularly suitable for outside dynamic use on people movers, railway vehicles (roof, bogie & underframe), public transit, robotic applications and solar tracking systems & arrays.



- High-grade, specially formulated polyamide 12
- Halogens and cadmium free
- Excellent weather and UV resistance
- Enhanced flexibility and fatigue strength
- Excellent mechanical strength (compression/impact) also at low temperatures and dry air conditions
- Self-extinguishing with very low smoke development
- Temperature range: -50°C(-58°F) to 95°C(203°F)
- Short-term to 150°C(302°F)

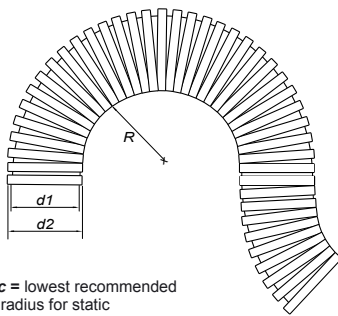

Rs static = lowest recommended bending radius for static (fixed) installation

Rd dynamic = lowest recommended bending radius for dynamic (flexible) installation

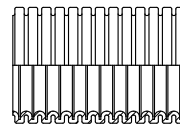

Fine Profile **F**
Tight bend radius

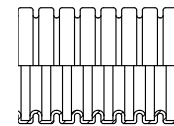

Coarse Profile **C**
High pull-out strength

Specifications are subject to change without notice

LHT

Order No.	Conduit Size		Trade Size		d1		d2		Rs Static		Rd Dynamic		PU	
	NW	mm	in	mm	in	mm	in	mm	in	mm	in	m	ft	
LHT-FK07.50	7	10	1/4	6.0	0.24	10.0	0.39	15.0	0.59	40.0	1.57	50	164.0	
LHT-FK10.50	10	12	5/16	9.2	0.36	13.0	0.51	20.0	0.79	50.0	1.97	50	164.0	
Ⓢ LHT-FK12.50	12	16	3/8	11.8	0.46	15.8	0.62	25.0	0.98	70.0	2.76	50	164.0	
Ⓢ LHT-FK17.50	17	20	1/2	16.0	0.63	21.2	0.83	30.0	1.18	80.0	3.15	50	164.0	
Ⓢ LHT-CK17.50	17	20	1/2	15.2	0.60	21.2	0.83	35.0	1.38	85.0	3.35	50	164.0	
Ⓢ LHT-CK23.50	23	25	3/4	22.0	0.87	28.5	1.12	40.0	1.57	110.0	4.33	50	164.0	
Ⓢ LHT-CK29.50	29	32	1	27.7	1.09	34.5	1.36	50.0	1.97	130.0	5.12	50	164.0	
Ⓢ LHT-CK36.30	36	40	1-1/4	35.8	1.41	42.5	1.67	60.0	2.36	180.0	7.09	30	98.4	
Ⓢ LHT-CK48.30	48	50	1-1/2	46.8	1.84	54.5	2.15	70.0	2.76	220.0	8.66	30	98.4	
LHT-CK56.30	56	68	2	56.0	2.20	67.2	2.65	130.0	5.12	280.0	11.02	30	98.4	
LHT-CK70.10	70	80	2-1/2-3	66.5	2.62	80.0	3.15	170.0	6.69	360.0	14.17	10	32.8	
LHT-CK95.10	95	106	3-1/2-4	91.3	3.59	106.0	4.17	250.0	9.84	470.0	18.50	10	32.8	

PME has excellent mechanical and flexibility characteristics and is designed for any installation with medium to high flexibility requirements. This versatile conduit / tubing is recommended for a wide variety of applications and uses including General Machine, Marine Engines, Hospital and Dental Equipment, Solar Panel Arrays, and Mechanical Wire & Cable Protection solutions.



- High-grade, specially formulated polyamide 6
- Halogens and cadmium free
- Good weather and UV resistance
- Good mechanical strength (compression / impact)
- Self-extinguishing
- Good temperature resistance
- Temperature range: -40°C(-40°F) to 105°C(221°F)
- Short-term to 160°C(320°F)

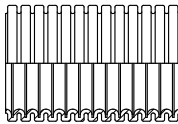

Fine Profile **F**
Tight bend radius

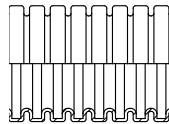

Coarse Profile **C**
High pull-out strength

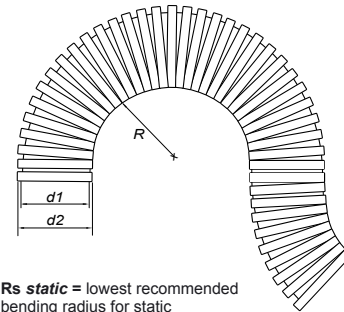

Rs static = lowest recommended bending radius for static (fixed) installation.

Specifications are subject to change without notice

PME

Order No.	Conduit Size		Trade Size		d1		d2		Rs Static		PU	
	NW	mm	in	mm	in	mm	in	mm	in	m	ft	
PME-FK07.50	7	10	1/4	6.2	0.24	10.0	0.39	15.0	0.59	50	164.0	
PME-FK10.50	10	12	5/16	9.6	0.38	13.0	0.51	20.0	0.79	50	164.0	
PME-FK12.50	12	16	3/8	12.0	0.47	15.8	0.62	30.0	1.18	50	164.0	
PME-FK17.50	17	20	1/2	16.2	0.64	21.2	0.83	40.0	1.57	50	164.0	
PME-FK23.50	23	25	3/4	22.6	0.89	28.5	1.12	45.0	1.77	50	164.0	
PME-FK29.50	29	32	1	29.0	1.14	34.5	1.36	55.0	2.17	50	164.0	
PME-FK36.30	36	40	1-1/4	36.5	1.44	42.5	1.67	60.0	2.36	30	98.4	
PME-FK48.30	48	50	1-1/2	48.5	1.91	54.5	2.15	70.0	2.76	30	98.4	
PME-CK56.30	56	68	2	56.3	2.22	67.2	2.65	130.0	5.12	30	98.4	
PME-CK70.10	70	80	2-1/2-3	67.5	2.66	80.0	3.15	160.0	6.30	10	32.8	
PME-CK95.10	95	106	3-1/2-4	91.5	3.60	106.0	4.17	210.0	8.27	10	32.8	

LHR is a highly flexible polyamide 12 conduit and is formulated specifically for flexibility, fatigue strength and exceptional abrasion resistance. This conduit is ideal for motion intensive applications such as automation and robotics as well as pneumatic and hydraulic actuators.



- High-grade, specially formulated polyamide 12
- Halogens and cadmium free
- Good weather and UV resistance
- Enhanced flexibility
- Excellent fatigue strength
- Enhanced abrasion resistance
- Good mechanical characteristics
- Temperature range: -50°C(-58°F) to 95°C(203°F)
- Short-term to 150 °C(302°F)

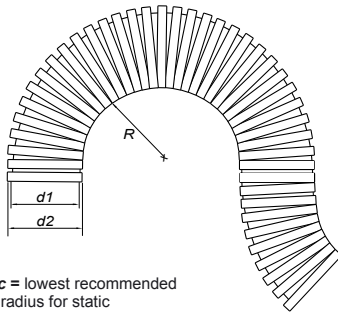

Rs static = lowest recommended bending radius for static (fixed) installation

Rd dynamic = lowest recommended bending radius for dynamic (flexible) installation

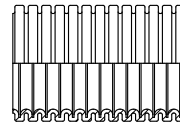

Fine Profile **F**
Tight bend radius

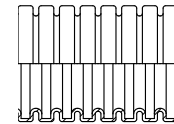

Coarse Profile **C**
High pull-out strength

Specifications are subject to change without notice

LHR

Order No.	Conduit Size	Trade Size		d1		d2		Rs Static		Rd Dynamic		PU	
	NW	mm	in	mm	in	mm	in	mm	in	mm	in	m	ft
LHR-FK07.50	7	10	1/4	6.2	0.24	10.0	0.39	15.0	0.59	40.0	1.57	50	164.0
LHR-FK10.50	10	12	5/16	9.6	0.38	13.0	0.51	20.0	0.79	50.0	1.97	50	164.0
LHR-FK12.50	12	16	3/8	11.9	0.47	15.8	0.62	25.0	0.98	65.0	2.56	50	164.0
LHR-FK17.50	17	20	1/2	16.4	0.65	21.2	0.83	30.0	1.18	65.0	2.56	50	164.0
LHR-FK23.50	23	25	3/4	22.6	0.89	28.5	1.12	35.0	1.38	90.0	3.54	50	164.0
LHR-FK29.50	29	32	1	29.0	1.14	34.5	1.36	45.0	1.77	110.0	4.33	50	164.0
LHR-FK36.30	36	40	1-1/4	36.5	1.44	42.5	1.67	60.0	2.36	165.0	6.50	30	98.4
LHR-FK48.30	48	50	1-1/2	47.5	1.87	54.5	2.15	70.0	2.76	180.0	7.09	30	98.4
LHR-CK17.50	17	20	1/2	15.2	0.6	21.2	0.83	30.0	1.18	80.0	3.15	50	164.0
LHR-CK23.50	23	25	3/4	21.7	0.85	28.5	1.12	40.0	1.57	100.0	3.94	50	164.0
LHR-CK29.50	29	32	1	27.4	1.08	34.5	1.36	50.0	1.97	120.0	4.72	50	164.0
LHR-CK36.30	36	40	1-1/4	35.8	1.41	42.5	1.67	60.0	2.36	180.0	7.09	30	98.4
LHR-CK48.30	48	50	1-1/2	46.7	1.84	54.5	2.15	70.0	2.76	200.0	7.87	30	98.4
LHR-CK56.30	56	68	2	56.0	2.2	67.2	2.65	110.0	4.33	270.0	10.63	30	98.4
LHR-CK70.10	70	80	2-1/2-3	67.2	2.65	80.0	3.15	150.0	5.91	350.0	13.78	10	32.8
LHR-CK70.30	70	80	2-1/2-3	67.2	2.65	80.0	3.15	150.0	5.91	350.0	13.78	30	98.4
LHR-CK95.10	95	106	3-1/2-4	91.3	3.59	106.0	4.17	170.0	6.69	450.0	17.72	10	32.8
LHR-CK95.30	95	106	3-1/2-4	91.3	3.59	106.0	4.17	170.0	6.69	450.0	17.72	30	98.4

This general use, all around conduit delivers very good flexibility, impact and fatigue strength making it an ideal fit for use in a wide range of application areas. This UL Listed conduit ensures compliance with the National Electrical Code (NEC) and the Canadian Electrical Code (CEC).



- High-grade, specially formulated polyamide 6
- Halogens and cadmium free
- Good mechanical strength (compression / impact)
- Good weather and UV resistance
- Self-extinguishing
- Temperature range: -40°C(-40°F) to 105°C(221°F)
- Short-term to 160°C(320°F)



PROFILE	NW
UCV-CK17.50	
TÛPE	PÛ

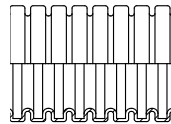

Coarse Profile C
High pull-out strength

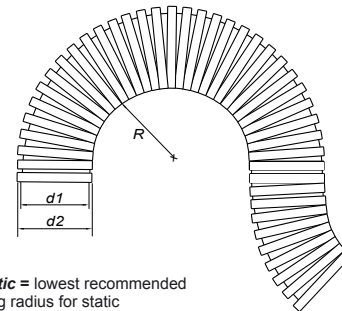

Rs static = lowest recommended bending radius for static (fixed) installation

Specifications are subject to change without notice

UCV



Order No.	Conduit Size		Trade Size		d1		d2		Rs Static		PU	
	NW	mm	in	mm	in	mm	in	mm	in	m	ft	
UCV-CK17.50	17	20	1/2	15.3	0.60	21.2	0.83	40.0	1.57	50	164.0	
UCV-CK23.50	23	25	3/4	21.9	0.86	28.5	1.12	45.0	1.77	50	164.0	
UCV-CK29.50	29	32	1	27.6	1.09	34.5	1.36	55.0	2.17	50	164.0	
UCV-CK36.30	36	40	1-1/4	36.0	1.42	42.5	1.67	60.0	2.36	30	98.4	
UCV-CK48.30	48	50	1-1/2	47.0	1.85	54.5	2.15	70.0	2.76	30	98.4	

LISTED

The heavy-walled CHS conduit demonstrates a very high degree of mechanical strength. Paired with enhanced fire retardant characteristics and minimal smoke development, it is ideal for use in static applications, the mining industry as well as heavy duty machinery and equipment manufacturing.



- High-grade, specially formulated polyamide 6
- Halogens and cadmium free
- Good weather and UV resistance
- Excellent mechanical strength (compression / impact)
- Enhanced fire retardant & very low smoke development
- Good temperature resistance
- Temperature range: -40°C(-40°F) to 105°C(221°F)
- Short-term to 160°C(320°F)

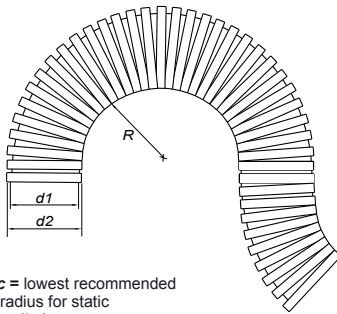

Rs static = lowest recommended bending radius for static (fixed) installation

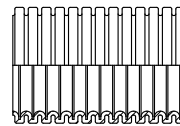

Fine Profile **F**
Tight bend radius

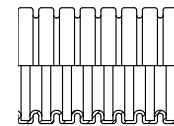

Coarse Profile **C**
High pull-out strength

Specifications are subject to change without notice

Order No.	Conduit Size		Trade Size		d1		d2		R Static		PU	
	NW	mm	in	mm	in	mm	in	mm	in	m	ft	
CHS-FK07.50	7	10	1/4	6.0	0.24	10.0	0.39	15.0	0.59	50	164.0	
CHS-FK10.50	10	12	5/16	9.2	0.36	13.0	0.51	20.0	0.79	50	164.0	
CHS-FK12.50	12	16	3/8	11.8	0.46	15.8	0.62	30.0	1.18	50	164.0	
CHS-FK17.50	17	20	1/2	16.0	0.63	21.2	0.83	40.0	1.57	50	164.0	
CHS-CK17.50	17	20	1/2	15.2	0.60	21.2	0.83	40.0	1.57	50	164.0	
CHS-CK23.50	23	25	3/4	22.0	0.87	28.5	1.12	45.0	1.77	50	164.0	
CHS-CK29.50	29	32	1	27.7	1.09	34.5	1.36	55.0	2.17	50	164.0	
CHS-CK36.30	36	40	1-1/4	35.8	1.41	42.5	1.67	60.0	2.36	30	98.4	
CHS-CK48.30	48	50	1-1/2	46.8	1.84	54.5	2.15	70.0	2.76	30	98.4	

This medium to heavy conduit / tubing has been developed to guarantee excellent resistance to chemicals and high temperatures. VMS is used in the chemical and food industries, particularly, in machine building, ovens and in many industrial applications where chemical corrosive agents and high temperatures are evident.

- High-grade polyvinylidene fluoride
- Very good weather and UV resistance
- Excellent mechanical strength (compression / impact) at high and low temperatures and dry air conditions
- Very-good abrasion resistance
- Temperature range: -60°C(-76°F) to 150°C(302°F)

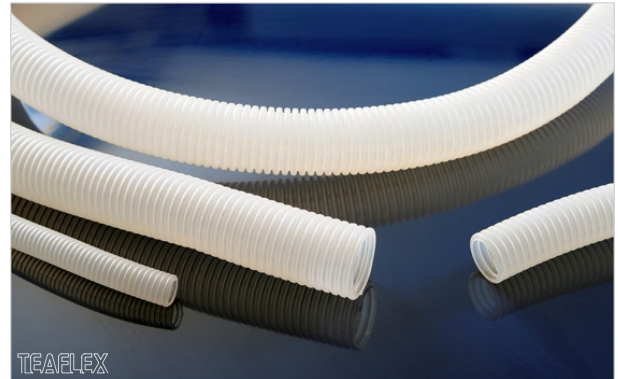

PROFILÉ	NW
VMS-FC12.50	
TÛPE	COLOUR
	PÛ

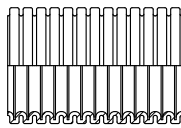

Fine Profile F
Tight bend radius

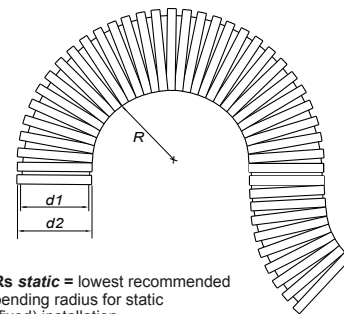

Rs static = lowest recommended bending radius for static (fixed) installation.

Specifications are subject to change without notice

Order No.	Conduit Size		Trade Size		d1		d2		Rs Static		PU	
	NW	mm	in	mm	in	mm	in	mm	in	m	ft	
VMS-FC10.50	10	12	5/16	9.6	0.38	13.0	0.51	20.0	0.79	50	164.0	
VMS-FC12.50	12	16	3/8	12.0	0.47	15.8	0.62	30.0	1.18	50	164.0	
VMS-FC17.50	17	20	1/2	16.2	0.64	21.2	0.83	40.0	1.57	50	164.0	
VMS-FC23.50	23	25	3/4	22.6	0.89	28.5	1.12	45.0	1.77	50	164.0	
VMS-FC29.50	29	32	1	29.0	1.14	34.5	1.36	55.0	2.17	50	164.0	

VMS

Polyvinyl Fluoride Special Fittings

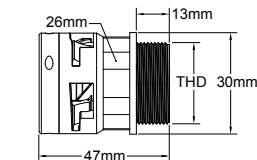

Order No.	THD	Conduit			
		IP66	PG	NW	Metric
C6-M-S-17P13	13.5	17	20	1/2	
C6-M-S-17P16	16	17	20	1/2	

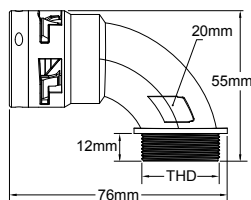

Order No.	THD	Conduit			
		IP66	PG	NW	Metric
C6-M-E-17P16	16	17	20	1/2	

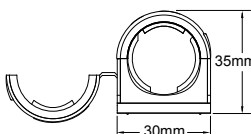

Order No.		Conduit		
		NW	Metric	inches
CX-C1-17	-	17	20	1/2

This conduit / tubing combines the technical characteristics of PME with the excellent mechanical strength of its metal braid jacketing. Owing to its special construction with the steel braid covering, PMB provides substantial protection against rodents, sparks, slag and hot chips found in braking systems, welding equipment and metal machining.



- High-grade, specially formulated polyamide 6
- Halogens, phosphor and cadmium free
- Covered with **galvanized carbon steel braid**
- Good mechanical strength (compression / impact)
- Self-extinguishing
- Good temperature resistance
- Temperature range: -40°C(-40°F) to 105°C(221°F)
- Short-term to 160°C(320°F)

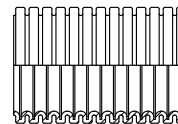
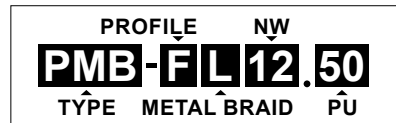
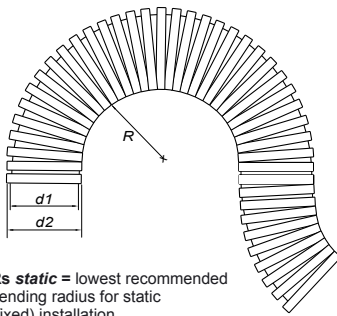

Fine Profile F
Tight bend radius

Specifications are subject to change without notice

PMB

Order No.	Conduit Size		Trade Size		d1		d2		Rs Static		PU		Ring	PU
	NW	mm	in	mm	in	mm	in	mm	in	m	ft	Brass nickel plated	ea	
PMB-FL07.50	7	10	1/4	6.2	0.24	11.0	0.43	15.0	0.59	50	164.0	PMBR-07	25	
PMB-FL10.50	10	12	5/16	9.6	0.38	14.0	0.55	20.0	0.79	50	164.0	PMBR-10	25	
CSA PMB-FL12.50	12	16	3/8	12.0	0.47	17.0	0.67	30.0	1.18	50	164.0	PMBR-12	25	
CSA PMB-FL17.50	17	20	1/2	16.2	0.64	22.5	0.89	40.0	1.57	50	164.0	PMBR-17	25	
CSA PMB-FL23.50	23	25	3/4	22.6	0.89	30.0	1.18	45.0	1.77	50	164.0	PMBR-23	25	
CSA PMB-FL29.50	29	32	1	29.0	1.14	36.0	1.42	55.0	2.17	50	164.0	PMBR-29	10	
CSA PMB-FL36.30	36	40	1-1/4	36.5	1.44	44.0	1.73	60.0	2.36	30	98.4	PMBR-36	10	
CSA PMB-FL48.30	48	50	1-1/2	48.5	1.91	56.0	2.20	70.0	2.76	30	98.4	PMBR-48	5	

TMF conduit / tubing is designed for use in the food industry. This highly specialized material is suitable for applications on machines and productive structures built for the formulation of food and beverages. TMF has an enhanced resistance to acids, bases and watery compounds and has the added advantage of acting like a high quality thermal insulator. TMF's outer material has been designed to cover and protect installed fittings from all possible food contaminants.



- Good weather and UV resistance
- Good mechanical strength and flexibility
- Temperature range: 0°C(32°F) to 100°C(212°F)
- Surface Hardness: 65 Shore A
- Enhanced resistance to ozone
- Flame retardant

Substances permitted for the conduit cleaning: water, water with chlorine, bleach, ammonia, basic substances.

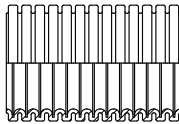

Fine Profile F
Tight bend radius

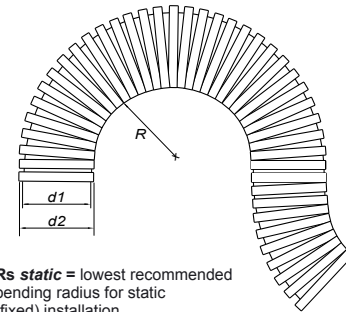

Rs static = lowest recommended bending radius for static (fixed) installation.

Specifications are subject to change without notice

Order No.	Conduit Size	Trade Size		d1		d2		Rs Static		PU	
	NW	mm	in	mm	in	mm	in	mm	in	m	ft
Ⓢ TMF-F12.50	12	16	3/8	11.8	0.46	18.8	0.74	30.0	1.18	50	164.0
Ⓢ TMF-F17.50	17	20	1/2	16.0	0.63	24.2	0.95	40.0	1.57	50	164.0
Ⓢ TMF-F23.50	23	25	3/4	22.4	0.88	31.5	1.24	45.0	1.77	50	164.0
Ⓢ TMF-F29.50	29	32	1	28.8	1.13	37.5	1.48	55.0	2.17	50	164.0
Ⓢ TMF-F36.30	36	40	1-1/4	36.5	1.44	44.0	1.73	60.0	2.36	30	98.0
Ⓢ TMF-F48.30	48	50	1-1/2	48.5	1.91	57.5	2.26	70.0	2.76	30	98.0

PHG conduit / tubing is produced from specially modified polyamide 6. This heavy duty material offers outstanding self-extinguishing characteristics and is halogens, phosphor and cadmium free. Owing to its self-extinguishing properties and low smoke gas development, PHG is used in the mining industry on a variety of applications including mobile and stationary mining equipment. PHG's distinctive green colour clearly identifies electrical wiring from hydraulic applications in darkened environments.



- High-grade, specially formulated polyamide 6
- Halogens, phosphor and cadmium free
- Good weather and UV resistance
- Good mechanical strength (compression / impact)
- Self-extinguishing with very low smoke development
- Good temperature resistance
- Temperature range: -40°C(-40°F) to 105°C(221°F)
Short-term to 160°C(320°F)

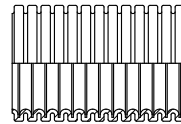
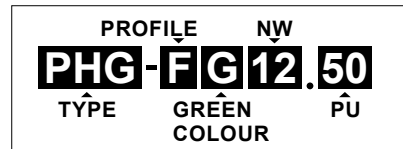
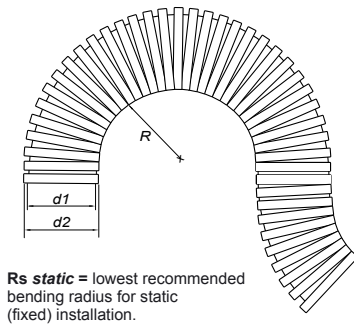

Fine Profile F
Tight bend radius

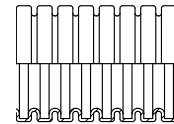

Coarse Profile C
High pull-out strength

Specifications are subject to change without notice

PHG

Order No.	Conduit Size		Trade Size		d1		d2		Rs Static		PU	
	NW	mm	in	mm	in	mm	in	mm	in	m	ft	
PHG-FG07.50	7	10	1/4	6.0	0.24	10.0	0.39	15.0	0.59	50	164.0	
PHG-FG10.50	10	12	5/16	9.2	0.36	13.0	0.51	20.0	0.79	50	164.0	
PHG-FG12.50	12	16	3/8	11.8	0.46	15.8	0.62	30.0	1.18	50	164.0	
PHG-FG17.50	17	20	1/2	16.0	0.63	21.2	0.83	40.0	1.57	50	164.0	
PHG-FG23.50	23	25	3/4	22.4	0.88	28.5	1.12	45.0	1.77	50	164.0	
PHG-CG29.50	29	32	1	27.6	1.09	34.5	1.36	55.0	2.17	50	164.0	
PHG-CG36.30	36	40	1-1/4	36.0	1.42	42.5	1.67	60.0	2.36	30	98.4	
PHG-CG48.30	48	50	1-1/2	46.8	1.84	54.5	2.15	70.0	2.76	30	98.4	

These highly flexible, heavy-grade conduits are characterized by outstanding resistance to weather and UV (sunlight) as well as by excellent low-temperature properties. They are used in the automotive industry, especially for exterior applications as well as for all applications involving movements in extreme weather conditions.



- High-grade, specially formulated polyamide 12
- Halogens and cadmium free
- Excellent weather and UV resistance
- Enhanced flexibility and fatigue strength
- Excellent mechanical strength (compression/impact) also at low temperatures and dry air conditions
- Self-extinguishing with very low smoke development
- Temperature range: -50°C(-58°F) to 95°C(203°F)
- Short-term to 150°C(302°F)

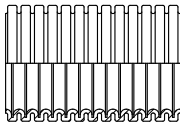
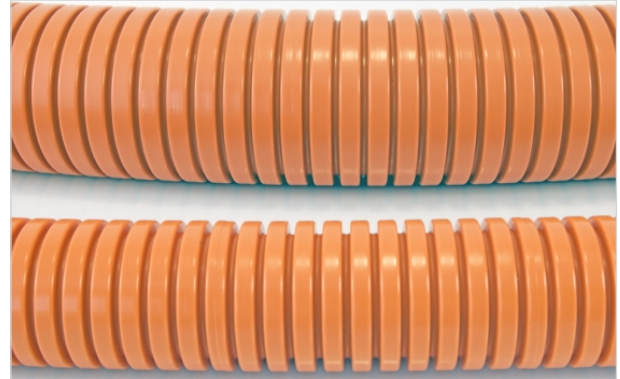

Fine Profile **F**
Tight bend radius

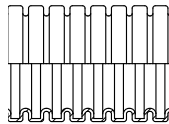

Coarse Profile **C**
High pull-out strength

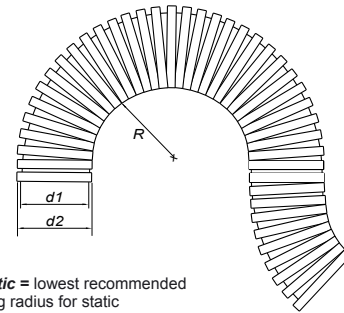

Rs static = lowest recommended bending radius for static (fixed) installation

Rd dynamic = lowest recommended bending radius for dynamic (flexible) installation

Specifications are subject to change without notice

HYB

Order No.	Conduit Size		Trade Size		d1		d2		Rs Static		Rd Dynamic		PU	
	NW	mm	in	mm	in	mm	in	mm	in	mm	in	m	ft	
HYB-FO07.50	7	10	1/4	6.0	0.24	10.0	0.39	15.0	0.59	40.0	1.57	50	164.0	
HYB-FO10.50	10	12	5/16	9.2	0.36	13.0	0.51	20.0	0.79	50.0	1.97	50	164.0	
HYB-FO12.50	12	16	3/8	11.8	0.46	15.8	0.62	25.0	0.98	70.0	2.76	50	164.0	
HYB-FO17.50	17	20	1/2	16.0	0.63	21.2	0.83	30.0	1.18	80.0	3.15	50	164.0	
HYB-CO17.50	17	20	1/2	15.2	0.60	21.2	0.83	35.0	1.38	85.0	3.35	50	164.0	
HYB-CO23.50	23	25	3/4	22.0	0.87	28.5	1.12	40.0	1.57	110.0	4.33	50	164.0	
HYB-CO29.50	29	32	1	27.7	1.09	34.5	1.36	50.0	1.97	130.0	5.12	50	164.0	
HYB-CO36.30	36	40	1-1/4	35.8	1.41	42.5	1.67	60.0	2.36	180.0	7.09	30	98.4	
HYB-CO48.30	48	50	1-1/2	46.8	1.84	54.5	2.15	70.0	2.76	220.0	8.66	30	98.4	
HYB-CO56.30	56	68	2	56.0	2.20	67.2	2.65	130.0	5.12	280.0	11.02	30	98.4	
HYB-CO70.10	70	80	2-1/2-3	66.5	2.62	80.0	3.15	170.0	6.69	360.0	14.17	10	32.8	
HYB-CO95.10	95	106	3-1/2-4	91.3	3.59	106.0	4.17	250.0	9.84	470.0	18.50	10	32.8	

This unique, corrugated, divisible conduit has been developed for a wide variety of retrofit and pre-loomed applications. New cables can be added to existing configurations without re-wiring, thus saving considerable time and cost. PMD's specially formulated polyamide 6 is halogens and cadmium free and provides good weather and UV resistance.



RoHS

- High-grade, specially formulated polyamide 6
- Halogens and cadmium free
- Good weather and UV resistance
- Good chemical properties
- Ingress protection up to IP54
- Temperature range: -40°C(-40°F) to 120°C(248°F)
- Short-term to 150°C(302°F)

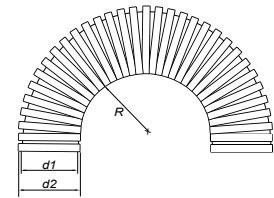

Rs static = lowest recommended bending radius for static (fixed) installation.

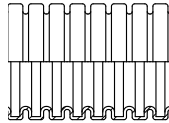

Coarse Profile C
High pull-out strength

PROFILE	NW
PMD-CK14.50	
TYPE	COLOUR
	PÙ

Specifications are subject to change without notice

PMD

Order No.	Conduit	d1		d2		Rs Static		PU	
	NW	mm	in	mm	in	mm	in	m	ft
PMD-CK10.50	10	8.8	0.35	13.5	0.54	55.0	2.17	50	164.0
PMD-CK14.50	14	13.2	0.50	18.7	0.74	75.0	2.95	50	164.0
PMD-CK20.50	20	20.2	0.79	25.7	1.02	105.0	4.13	50	164.0
PMD-CK23.50	23	23.9	0.98	31.3	1.24	125.0	4.92	50	164.0
PMD-CK29.25	29	27.3	1.25	35.5	1.65	170.0	6.69	25	82.0
PMD-CK37.25	37	32.5	1.25	43.2	1.65	170.0	6.69	25	82.0
PMD-CK45.25	45	43.1	1.70	54.2	2.13	170.0	6.69	25	82.0
PMD-CK70.10	70	67.0	2.60	79.8	3.13	300.0	11.81	10	32.8

NMD Polypropylene Divisible Conduit

Formulated from specially modified polypropylene, NMD provides good weather and UV resistance and is a rugged and fatigue resistant protective covering. This unique, corrugated, divisible conduit is used on retrofit and pre-loomed applications where new cables can be added to existing configurations, thus saving considerable time and cost.



RoHS

- High-grade, specially modified polypropylene
- Easy installation
- Good weather and UV resistance
- Very good chemical properties
- Ingress protection up to IP54
- Temperature range: -40°C(-40°F) to 135°C(275°F)
- Short-term to 150°C(302°F)

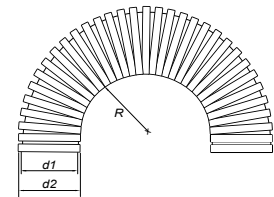

Rs static = lowest recommended bending radius for static (fixed) installation.

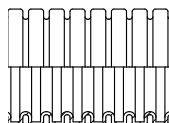

Coarse Profile C
High pull-out strength

PROFILE	NW
NMD-CK14.50	
TYPE	COLOUR
	PÙ

Specifications are subject to change without notice

NMD

Order No.	Conduit	d1		d2		Rs Static		PU	
	NW	mm	in	mm	in	mm	in	m	ft
NMD-CK10.50	10	8.4	0.33	13.4	0.53	70.0	2.76	50.0	164.0
NMD-CK14.50	14	12.5	0.49	18.5	0.73	95.0	3.74	50.0	164.0
NMD-CK20.50	20	19.2	0.76	25.3	1.00	130.0	5.12	50.0	164.0
NMD-CK23.50	23	23.4	0.92	30.8	1.21	155.0	6.10	50.0	164.0
NMD-CK29.25	29	27.3	1.22	35.5	1.63	190.0	7.48	25.0	82.0
NMD-CK37.25	37	31.0	1.22	41.4	1.63	195.0	7.48	25.0	82.0
NMD-CK45.25	45	42.7	1.68	54.0	2.13	205.0	8.07	25.0	82.0
NMD-CK70.10	70	67.5	2.60	79.8	3.13	300.0	11.81	10.0	32.8

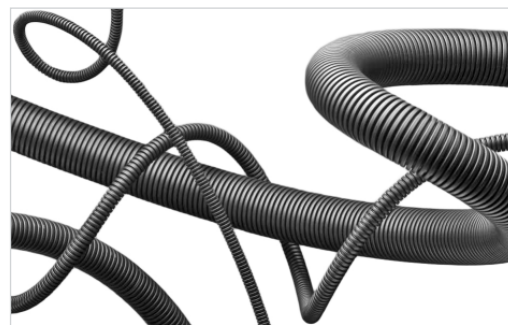
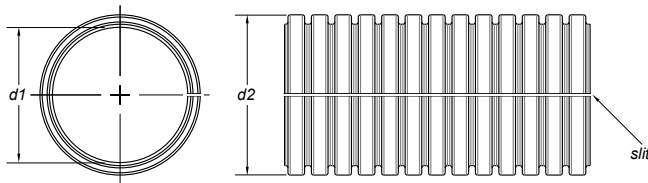

Specifications are subject to change without notice

PLF

Order No.	Conduit Size		d1		d2		PU	
	NW	mm	in	mm	in	m	ft	
PLF-SK06.50	6	6.3	0.25	8.7	0.34	50	164.0	
PLF-SK08.50	7.5	6.8	0.27	10.0	0.39	50	164.0	
PLF-SK09.50	8.5	8.6	0.34	11.5	0.45	50	164.0	
PLF-SK10.50	10	10.0	0.39	12.8	0.50	50	164.0	
PLF-SK11.50	11	10.7	0.42	13.6	0.54	50	164.0	
PLF-SK12.50	12	12.5	0.49	15.7	0.62	50	164.0	
PLF-SK13.50	13	12.9	0.51	16.0	0.63	50	164.0	
PLF-SK14.50	14	14.4	0.57	18.5	0.73	50	164.0	
PLF-SK16.50	16	15.1	0.59	18.9	0.74	50	164.0	
PLF-SK17.50	17	16.8	0.66	21.1	0.83	50	164.0	
PLF-SK19.50	19	19.5	0.77	24.2	0.95	50	164.0	
PLF-SK22.50	22	21.7	0.85	25.7	1.01	50	164.0	
PLF-SK23.50	23	23.4	0.92	28.4	1.12	50	164.0	
PLF-SK26.50	26	26.0	1.02	31.2	1.23	50	164.0	
PLF-SK29.25	29	29.2	1.15	34.5	1.36	25	82.0	
PLF-SK33.25	33	33.0	1.30	38.3	1.51	25	82.0	
PLF-SK37.25	37	34.0	1.34	41.8	1.65	25	82.0	
PLF-SK50.25	50	46.0	1.81	53.8	2.12	25	82.0	
PLF-SK65.25	65	62.7	2.47	73.5	2.89	25	82.0	
PLF-SK75.25	75	77.0	3.03	85.2	3.35	25	82.0	

TYPE COLOUR
PLF-SK12.50
 SLIT NW PU

- Specially formulated polyamide 6 light version
- Halogens and cadmium free
- Good weather and UV resistance
- Self-extinguishing
- Good temperature resistance
- Temperature range: -30°C(-22°F) to 120°C(248°F)
- Short-term to 150°C(302°F)

NLF

Order No.	Conduit Size		d1		d2		PU	
	NW	mm	in	mm	in	m	ft	
NLF-SK03.100	3	3.0	0.12	5.1	0.20	100	328.1	
NLF-SK04.100	4.5	4.8	0.19	7.1	0.28	100	328.1	
NLF-SK05.100	5	5.0	0.20	7.1	0.28	100	328.1	
NLF-SK06.50	6	6.0	0.24	8.6	0.34	50	164.0	
NLF-SK08.50	7.5	6.9	0.27	9.9	0.39	50	164.0	
NLF-SK09.50	8.5	8.5	0.33	11.4	0.45	50	164.0	
NLF-SK10.50	10	10.1	0.40	12.6	0.50	50	164.0	
NLF-SK11.50	11	10.8	0.43	13.6	0.54	50	164.0	
NLF-SK12.50	12	12.0	0.47	15.6	0.61	50	164.0	
NLF-SK13.50	13	12.9	0.51	15.8	0.62	50	164.0	
NLF-SK14.50	14	14.5	0.57	18.4	0.72	50	164.0	
NLF-SK16.50	16	15.2	0.60	18.7	0.74	50	164.0	
NLF-SK17.50	17	16.8	0.66	21.0	0.83	50	164.0	
NLF-SK19.50	19	19.4	0.76	24.0	0.94	50	164.0	
NLF-SK22.50	22	21.8	0.86	25.5	1.00	50	164.0	
NLF-SK23.50	23	23.7	0.93	28.0	1.10	50	164.0	
NLF-SK26.50	26	26.1	1.03	31.0	1.22	50	164.0	
NLF-SK29.25	29	29.3	1.15	33.9	1.33	25	82.0	
NLF-SK33.25	33	33.1	1.30	38.2	1.50	25	82.0	
NLF-SK37.25	37	33.8	1.33	41.6	1.64	25	82.0	
NLF-SK50.25	50	45.7	1.80	53.2	2.09	25	82.0	
NLF-SK65.25	65	63.0	2.48	73.9	2.91	25	82.0	
NLF-SK75.25	75	76.7	3.02	84.8	3.34	25	82.0	
NLF-SK100.25	100	101.0	3.98	110.0	4.33	25	82.0	

TYPE COLOUR
NLF-SK12.50
 SLIT NW PU

- High-grade, specially modified polypropylene
- Easy installation
- Good weather and UV resistance
- Very good chemical properties
- Halogens and cadmium free
- Temperature range: -40°C(-40°F) to 105°C(221°F)
- Short-term to 130°C(266°F)

MPT



Polyethylene Braided Sleeve

Order Number	Nominal Size	Min. ID		Max. ID	
	NW	mm	in	mm	in
MPT0.25BK.60	1/4	3.2	1/8	11.1	0.438
MPT0.50BK.30	1/2	6.4	1/4	19.1	0.750
MPT0.75BK.22	3/4	12.7	1/2	31.8	1.250
MPT1.25BK.15	1 1/4	19.1	3/4	44.5	1.750
MPT1.75BK.9	1 3/4	31.8	1 1/4	69.9	2.750



- Economical and easy to install
- Cut and abrasion resistant
- Expands up to 150%
- Halogen free
- Resists gasoline, engine chemicals and cleaning solvents
- FMVSS 302 approved

Detailed technical specifications: <http://www.moltecinternational.com/datasheets/mpt.pdf>

MNH

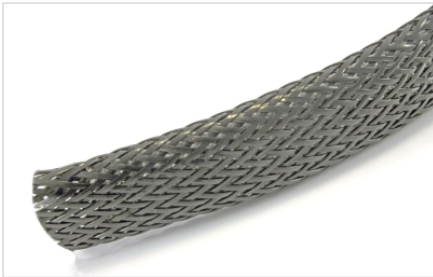

Flat Filaments Sleeve

Order Number	Nominal Size	Min. ID		Max. ID	
	NW	mm	in	mm	in
MNH0.50BK.30	1/2	9.5	3/8	15.9	0.625
MNH0.75BK.15	3/4	15.9	5/8	25.4	1.000
MNH1.75BK.7.5	1 3/4	38.1	1 1/2	50.8	2.000



- Innovative braided flat filament technology
- Resists damage from UV, gasoline, engine chemicals & salt water
- Heavy plastic protection
- Smooth inner wall reduces internal abrasion
- Extreme cut and abrasion resistant
- Halogen free
- Colour: black

Detailed technical specifications: <http://www.moltecinternational.com/datasheets/mnh.pdf>

MDP



Tubular Weave Sleeve

Order Number	Nominal Size	Wall Thickness	
		mm	in
MDP0.75BK.15	3/4	2.0	0.08
MDP1.25BK.15	1 1/4	2.0	0.08
MDP2.19BK.15	2 3/16	2.0	0.08



- Heavy duty, .08" wall thickness
- ISO 6945 certified
- Professional grade construction
- Smooth inner wall prevents internal abrasion damage
- Braided nylon resists UV, salt, chemicals, vermin & rot
- Halogen free
- Colour: black

Detailed technical specifications: <http://www.moltecinternational.com/datasheets/mdp.pdf>

MFG



Resin Coated Fiberglass

Order Number	Nominal Size (NW)	Max. ID		Wall Thickness	
		mm	in	mm	in
MFG0.38BK.15	3/8	15.9	5/8	1.09	0.043
MFG0.50BK.15	1/2	19.1	3/4	1.17	0.046
MFG0.75BK.15	3/4	28.6	1 1/8	1.17	0.046



- UL recognized
- Resin coated, heavy weight fiberglass won't burn, melt or become brittle
- Up to 650 °C [1,200 °F]
- Easy to install-cuts with scissors
- Resists gasoline and engine chemicals
- Cut and abrasion resistant
- Colour: Black (BK)
Silver (SV)

Detailed technical specifications: <http://www.moltecinternational.com/datasheets/mfg.pdf>



- VW-1, Mil-202 approved
- Economical and easy to install
- Cut and abrasion resistant
- Resists gasoline & engine chemicals
- Hook and loop closure for easy and repeatable access
- Colour: Black w/ White tracer (TB)

Braided Wrap Sleeve

Order Number	Nominal Size	Hook & Loop width	
	NW	mm	in
MFW0.50TB.20	1/2	6.40	0.251
MFW0.75TB.15	3/4	15.90	0.625
MFW1.25TB.12	1 1/4	15.90	0.625
MFW2.00TB.10	2	15.90	0.625
MFW2.50TB.10	2 1/2	15.80	0.625



MFW

Detailed technical specifications: <http://www.molteciinternational.com/datasheets/mfw.pdf>



- VW-1, FAR 25
- Cost effective wraparound installation
- 25% edge overlap
- Resists chemicals & solvents
- Cut and abrasion resistant
- Colour: Black w/ White tracer (TB)

Flame Inhibitor Wrap

Order Number	Nominal Size	Wall Thickness	
	NW	mm	in
MFR0.25TB.30	1/4	0.64	0.025
MFR0.50TB.22	1/2	0.64	0.025
MFR0.75TB.15	3/4	0.64	0.025
MFR1.00TB.15	1	0.97	0.038



MFR

Detailed technical specifications: <http://www.molteciinternational.com/datasheets/mfr.pdf>



- Tightly woven ballistic nylon construction
- Heavy duty, oversize hook and loop closure
- Repels liquids
- Resists and prevents damage from UV, abrasion, gasoline & engine chemicals
- Deflects high pressure hose ruptures
- Colour: Black

Ballistic Nylon Wrap

Order Number	Nominal Size (NW)	Velcro Width		Wall Thickness	
		mm	in	mm	in
MDW1.00BK.7.5	1	25.4	1.00	6.6	0.26
MDW1.50BK.7.5	1 1/2	25.4	1.00	6.6	0.26
MDW2.00BK.7.5	2	25.4	1.00	6.6	0.26
MDW2.50BK.7.5	2 1/2	25.4	1.00	6.6	0.26

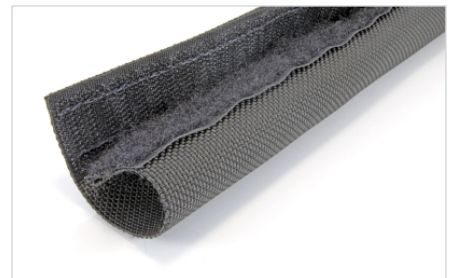

MDW

Detailed technical specifications: <http://www.molteciinternational.com/datasheets/mdw.pdf>



- Easy to install, cuts with scissors
- Resists damage from UV, gasoline & engine chemicals
- Weld splatter, hot slag and welding spark protection
- Stays flexible in low temperatures
- Colour: Black (BK)

Fiberglass Wrap Sleeve

Order Number	Nominal Size (NW)	Velcro Width		Wall Thickness	
		mm	in	mm	in
MWW1.00BK.15	1	21.3	0.84	1.0	0.04
MWW2.00BK.15	2	39.4	1.55	1.0	0.04
MWW3.00BK.15	3	39.4	1.55	1.0	0.04
MWW4.00BK.15	4	39.4	1.55	1.0	0.04



MWW

Detailed technical specifications: <http://www.molteciinternational.com/datasheets/mww.pdf>

TEAFLEX



- Locking device system provides a quick and secure push-in connection of corrugated conduits
- High-grade formulated polyamide
- Self-extinguishing, free from halogens and cadmium
- Excellent impact strength
- Temperature range: -40°C(-40°F) to 105°C(221°F)
- Short-term to 160°C(320°F)
- Up to IP68 / NEMA 6P protection with the reinforced sealing cap at conduit side
- Colour: Black standard, other colours available upon request

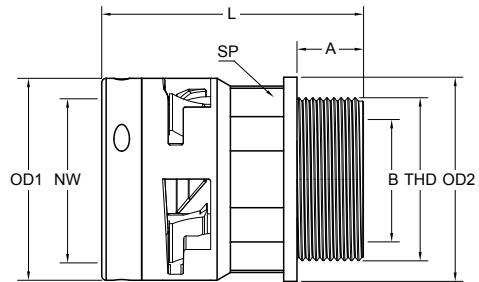
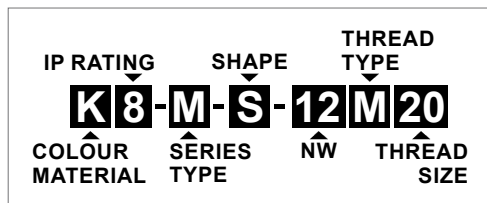

Specifications are subject to change without notice

**METRIC
THREAD**

Order No. IP66	Order No. IP68	THD Metric	Fits to Conduit			A		B		L		OD1		OD2		SP	
			NW	mm	in	mm	in	mm	in	mm	in	mm	in	mm	in		
K6-M-S-07M12	K8-M-S-07M12	M12x1.5	7	10	1/4	12.0	0.47	9.0	0.35	40.0	1.57	17.0	0.67	17.0	0.67	14.0	0.55
K6-M-S-07M16	K8-M-S-07M16	M16x1.5	7	10	1/4	12.0	0.47	9.0	0.35	40.0	1.57	17.0	0.67	20.0	0.79	14.0	0.55
K6-M-S-10M12	K8-M-S-10M12	M12x1.5	10	12	5/16	12.0	0.47	8.8	0.35	41.4	1.63	20.0	0.79	20.0	0.79	17.0	0.67
K6-M-S-10M16	K8-M-S-10M16	M16x1.5	10	12	5/16	12.0	0.47	10.5	0.41	41.4	1.63	20.0	0.79	20.0	0.79	17.0	0.67
K6-M-S-10M20	K8-M-S-10M20	M20x1.5	10	12	5/16	12.0	0.47	15.0	0.59	41.4	1.63	20.0	0.79	24.0	0.94	17.0	0.67
Ⓢ K6-M-S-12M16	K8-M-S-12M16	M16x1.5	12	16	3/8	12.0	0.47	11.0	0.43	44.7	1.76	24.0	0.94	24.0	0.94	20.0	0.79
Ⓢ K6-M-S-12M20	K8-M-S-12M20	M20x1.5	12	16	3/8	12.0	0.47	13.0	0.51	44.7	1.76	24.0	0.94	26.0	1.02	20.0	0.79
Ⓢ K6-M-S-17M20	K8-M-S-17M20	M20x1.5	17	20	1/2	13.0	0.51	14.0	0.55	46.9	1.84	30.0	1.18	28.0	1.10	26.0	1.02
Ⓢ K6-M-S-17M25	K8-M-S-17M25	M25x1.5	17	20	1/2	13.0	0.51	18.5	0.73	46.9	1.84	30.0	1.18	30.0	1.18	26.0	1.02
Ⓢ K6-M-S-23M25	K8-M-S-23M25	M25x1.5	23	25	3/4	14.0	0.55	19.0	0.75	57.0	2.24	38.0	1.50	38.0	1.50	32.0	1.26
Ⓢ K6-M-S-23M32	K8-M-S-23M32	M32x1.5	23	25	3/4	14.0	0.55	27.0	1.06	57.0	2.24	38.0	1.50	40.0	1.57	32.0	1.26
Ⓢ K6-M-S-29M32	K8-M-S-29M32	M32x1.5	29	32	1	15.0	0.59	26.0	1.02	59.0	2.32	45.5	1.79	46.0	1.81	40.0	1.57
Ⓢ K6-M-S-29M40	K8-M-S-29M40	M40x1.5	29	32	1	15.0	0.59	33.5	1.32	59.0	2.32	45.5	1.79	46.0	1.81	40.0	1.57
Ⓢ K6-M-S-36M40	K8-M-S-36M40	M40x1.5	36	40	1-1/4	17.0	0.67	33.7	1.33	69.0	2.72	57.0	2.24	54.0	2.13	50.0	1.97
Ⓢ K6-M-S-36M50	K8-M-S-36M50	M50x1.5	36	40	1-1/4	17.0	0.67	40.0	1.57	69.0	2.72	57.0	2.24	58.0	2.28	50.0	1.97
Ⓢ K6-M-S-48M50	K8-M-S-48M50	M50x1.5	48	50	1-1/2	17.0	0.67	42.0	1.65	75.5	2.97	68.0	2.68	66.0	2.60	64.0	2.52
Ⓢ K6-M-S-48M63	K8-M-S-48M63	M63x1.5	48	50	1-1/2	17.0	0.67	49.0	1.93	75.5	2.97	68.0	2.68	70.0	2.76	64.0	2.52



NPT
THREAD

Order No.	Order No.	THD	Fits to Conduit			A		B		L		OD1		OD2		SP	
			IP66	IP68	NPT	NW	mm	in	mm	in	mm	in	mm	in	mm	in	mm
K6-M-S-12N02	K8-M-S-12N02	1/2	12	16	3/8	13.5	0.53	14.0	0.55	46.0	1.81	24.0	0.94	26.0	1.02	20.0	0.79
K6-M-S-17N02	K8-M-S-17N02	1/2	17	20	1/2	13.5	0.53	15.0	0.59	47.4	1.86	30.0	1.18	28.0	1.10	26.0	1.02
K6-M-S-23N04	K8-M-S-23N04	3/4	23	25	3/4	14.0	0.55	20.0	0.79	57.0	2.24	38.0	1.50	38.0	1.50	32.0	1.26
K6-M-S-29N06	K8-M-S-29N06	1	29	32	1	17.3	0.68	26.0	1.02	61.3	2.41	45.5	1.79	46.0	1.81	40.0	1.57
K6-M-S-36N07	K8-M-S-36N07	1-1/4	36	40	1-1/4	18.0	0.71	33.7	1.33	70.0	2.76	57.0	2.24	54.0	2.13	50.0	1.97
K6-M-S-48N09	K8-M-S-48N09	2	48	50	1-1/2	19.0	0.75	50.0	1.97	77.5	3.05	68.0	2.68	70.0	2.76	64.0	2.52

PG
THREAD

Order No.	Order No.	THD	Fits to Conduit			A		B		L		OD1		OD2		SP	
			IP66	IP68	PG	NW	mm	in	mm	in	mm	in	mm	in	mm	in	mm
K6-M-S-07P07	K8-M-S-07P07	7	7	10	1/4	12.0	0.47	9.0	0.35	40.0	1.57	17.0	0.67	17.0	0.67	14.0	0.55
K6-M-S-07P09	K8-M-S-07P09	9	7	10	1/4	12.0	0.47	9.0	0.35	40.0	1.57	17.0	0.67	17.0	0.67	14.0	0.55
K6-M-S-07P11	K8-M-S-07P11	11	7	10	1/4	12.0	0.47	15.0	0.59	40.0	1.57	17.0	0.67	22.0	0.87	14.0	0.55
K6-M-S-07P13	K8-M-S-07P13	13.5	7	10	1/4	12.0	0.47	15.0	0.59	40.0	1.57	17.0	0.67	22.0	0.87	14.0	0.55
K6-M-S-10P07	K8-M-S-10P07	7	10	12	5/16	12.0	0.47	8.8	0.35	41.4	1.63	20.0	0.79	20.0	0.79	17.0	0.67
K6-M-S-10P09	K8-M-S-10P09	9	10	12	5/16	12.0	0.47	10.5	0.41	41.4	1.63	20.0	0.79	20.0	0.79	17.0	0.67
K6-M-S-10P11	K8-M-S-10P11	11	10	12	5/16	12.0	0.47	15.0	0.59	41.4	1.63	20.0	0.79	24.0	0.94	17.0	0.67
K6-M-S-10P13	K8-M-S-10P13	13.5	10	12	5/16	12.0	0.47	15.0	0.59	41.4	1.63	20.0	0.79	24.0	0.94	17.0	0.67
K6-M-S-12P09	K8-M-S-12P09	9	12	16	3/8	12.0	0.47	11.0	0.43	44.7	1.76	24.0	0.94	24.0	0.94	20.0	0.79
K6-M-S-12P11	K8-M-S-12P11	11	12	16	3/8	12.0	0.47	13.0	0.51	44.7	1.76	24.0	0.94	24.0	0.94	20.0	0.79
K6-M-S-12P13	K8-M-S-12P13	13.5	12	16	3/8	12.0	0.47	13.0	0.51	44.7	1.76	24.0	0.94	26.0	1.02	20.0	0.79
K6-M-S-12P16	K8-M-S-12P16	16	12	16	3/8	12.0	0.47	15.0	0.59	44.7	1.76	24.0	0.94	26.0	1.02	20.0	0.79
K6-M-S-17P11	K8-M-S-17P11	11	17	20	1/2	13.0	0.51	14.0	0.55	46.9	1.84	30.0	1.18	28.0	1.10	26.0	1.02
K6-M-S-17P13	K8-M-S-17P13	13.5	17	20	1/2	13.0	0.51	16.0	0.63	46.9	1.84	30.0	1.18	28.0	1.10	26.0	1.02
K6-M-S-17P16	K8-M-S-17P16	16	17	20	1/2	13.0	0.51	16.0	0.63	46.9	1.84	30.0	1.18	30.0	1.18	26.0	1.02
K6-M-S-23P16	K8-M-S-23P16	16	23	25	3/4	14.0	0.55	19.0	0.75	57.0	2.24	38.0	1.50	38.0	1.50	32.0	1.26
K6-M-S-23P21	K8-M-S-23P21	21	23	25	3/4	14.0	0.55	22.0	0.87	57.0	2.24	38.0	1.50	38.0	1.50	32.0	1.26
K6-M-S-29P29	K8-M-S-29P29	29	29	32	1	15.0	0.59	30.5	1.20	59.0	2.32	45.5	1.79	46.0	1.81	40.0	1.57
K6-M-S-36P29	K8-M-S-36P29	29	36	40	1-1/4	13.0	0.67	31.5	1.24	65.0	2.72	57.0	2.24	54.0	2.13	50.0	1.97
K6-M-S-36P36	K8-M-S-36P36	36	36	40	1-1/4	17.0	0.67	38.0	1.50	69.0	2.72	57.0	2.24	58.0	2.28	50.0	1.97
K6-M-S-48P36	K8-M-S-48P36	36	48	50	1-1/2	17.0	0.67	40.0	1.57	75.5	2.97	68.0	2.68	66.0	2.60	64.0	2.52
K6-M-S-48P42	K8-M-S-48P42	42	48	50	1-1/2	17.0	0.67	47.0	1.85	75.5	2.97	68.0	2.68	66.0	2.60	64.0	2.52
K6-M-S-48P48	K8-M-S-48P48	48	48	50	1-1/2	17.0	0.67	49.0	1.93	75.5	2.97	68.0	2.68	70.0	2.76	64.0	2.52

UL
LISTED

BSM UL Listed, Straight Male Thread, Polyamide Connector



Order No.	THD	Fits to Conduit			A		B		L		OD1		OD2		SP	
		NEMA 4X	NPT	NW	mm	in	mm	in	mm	in	mm	in	mm	in	mm	in
6BSM17N03	1/2	17	20	1/2	13.5	0.53	15.0	0.59	47.4	1.86	30.0	1.18	28.0	1.10	26.0	1.02
6BSM23N04	3/4	23	25	3/4	14.0	0.55	20.0	0.79	57.0	2.24	38.0	1.50	38.0	1.50	32.0	1.26
6BSM29N05	1	29	32	1	17.3	0.68	26.0	1.02	61.3	2.41	45.5	1.79	46.0	1.81	40.0	1.57
6BSM36N06	1-1/4	36	40	1-1/4	18.0	0.71	33.7	1.33	70.0	2.76	57.0	2.24	54.0	2.13	50.0	1.97
6BSM48N08	2	48	50	1-1/2	19.0	0.75	50.0	1.97	77.5	3.05	68.0	2.68	70.0	2.76	64.0	2.52

TEAFLEX



- Locking device system provides a quick and secure push-in connection of corrugated conduits
- High-grade formulated polyamide
- Self-extinguishing, free from halogens and cadmium
- Excellent impact strength
- Temperature range: -40°C(-40°F) to 105°C(221°F)
- Short-term to 160°C(320°F)
- Up to IP68 / NEMA 6P protection with the reinforced sealing cap at conduit side
- Colour: Black standard, other colours available upon request

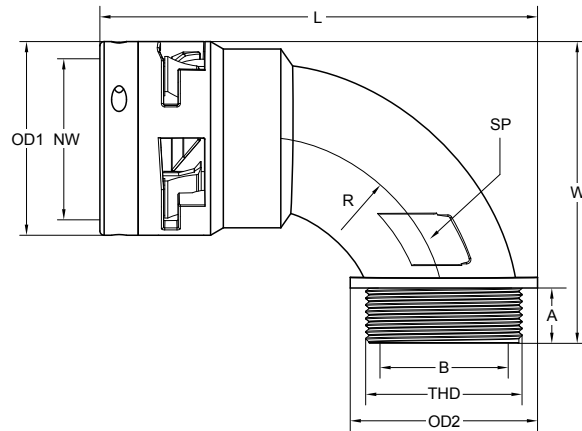
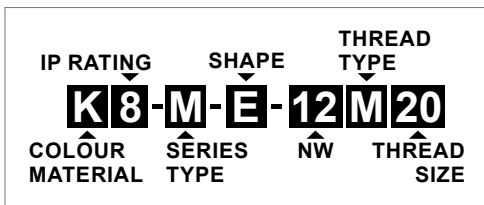

Specifications are subject to change without notice

**METRIC
THREAD**

Order No.	Order No.	THD	Fits to Conduit			A		B		L		R		W		OD1		OD2		SP	
			IP66	IP68	Metric	NW	mm	in	mm	in	mm	in	mm	in	mm	in	mm	in	mm	in	mm
K6-M-E-07M12	K8-M-E-07M12	M12x1.5	7	10	1/4	11.0	0.43	6.5	0.26	58.5	2.30	31.2	1.23	41.7	1.64	17.0	0.67	18.0	0.71	9.5	0.37
K6-M-E-10M12	K8-M-E-10M12	M12x1.5	10	12	5/16	11.0	0.43	6.5	0.26	59.5	2.34	31.2	1.23	43.2	1.70	20.0	0.79	18.0	0.71	9.5	0.37
K6-M-E-10M16	K8-M-E-10M16	M16x1.5	10	12	5/16	11.0	0.43	10.0	0.39	61.5	2.42	31.2	1.23	43.2	1.70	20.0	0.79	22.0	0.87	13.0	0.51
K6-M-E-12M16	K8-M-E-12M16	M16x1.5	12	16	3/8	11.0	0.43	10.0	0.39	64.0	2.52	31.7	1.25	45.7	1.80	24.0	0.94	22.0	0.87	14.0	0.55
K6-M-E-12M20	K8-M-E-12M20	M20x1.5	12	16	3/8	11.0	0.43	12.0	0.47	67.0	2.64	31.7	1.25	45.7	1.80	24.0	0.94	26.0	1.02	15.0	0.59
K6-M-E-17M20	K8-M-E-17M20	M20x1.5	17	20	1/2	12.0	0.47	13.8	0.54	75.0	2.95	36.6	1.44	55.2	2.17	30.0	1.18	26.0	1.02	17.0	0.67
K6-M-E-23M25	K8-M-E-23M25	M25x1.5	23	25	3/4	12.0	0.47	18.0	0.71	88.5	3.48	41.5	1.63	61.2	2.41	38.0	1.50	32.0	1.26	22.0	0.87
K6-M-E-29M32	K8-M-E-29M32	M32x1.5	29	32	1	13.0	0.51	23.7	0.93	100.3	3.95	47.5	1.87	70.9	2.79	45.5	1.79	39.0	1.54	28.0	1.10
K6-M-E-36M40	K8-M-E-36M40	M40x1.5	36	40	1-1/4	15.0	0.59	31.8	1.25	122.8	4.83	59.4	2.34	87.5	3.44	57.0	2.24	50.0	1.97	36.0	1.42
K6-M-E-36M50	K8-M-E-36M50	M50x1.5	36	40	1-1/4	15.0	0.59	36.0	1.42	127.5	5.02	59.4	2.34	88.0	3.46	57.0	2.24	60.0	2.36	40.0	1.57
K6-M-E-48M50	K8-M-E-48M50	M50x1.5	48	50	1-1/2	15.0	0.59	39.8	1.57	139.7	5.50	63.3	2.49	96.7	3.81	68.0	2.68	60.0	2.36	46.0	1.81
K6-M-E-48M63	K8-M-E-48M63	M63x1.5	48	50	1-1/2	15.0	0.59	47.8	1.88	144.0	5.67	63.3	2.49	96.7	3.81	68.0	2.68	70.0	2.76	55.0	2.17

**KME**

90° Elbow, Male Thread, Polyamide Connector

**NPT
THREAD**

Order No.	Order No.	THD	Fits to Conduit			A		B		L		R		W		OD1		OD2		SP	
			IP66	IP68	NPT	NW	mm	in	mm	in	mm	in	mm	in	mm	in	mm	in	mm	in	mm
Ⓢ K6-M-E-12N02	K8-M-E-12N02	1/2	12	16	3/8	11.0	0.43	12.0	0.47	66.4	2.61	31.7	1.25	45.7	1.80	24.0	0.94	27.0	1.06	15.0	0.59
Ⓢ K6-M-E-17N02	K8-M-E-17N02	1/2	17	20	1/2	13.5	0.53	13.8	0.54	75.5	2.97	36.6	1.44	56.2	2.21	30.0	1.18	27.0	1.06	17.0	0.67
Ⓢ K6-M-E-23N04	K8-M-E-23N04	3/4	23	25	3/4	14.0	0.55	18.0	0.71	89.5	3.52	41.5	1.63	63.2	2.49	38.0	1.50	34.0	1.34	22.0	0.87
Ⓢ K6-M-E-29N06	K8-M-E-29N06	1	29	32	1	17.3	0.68	23.7	0.93	101.3	3.99	47.5	1.87	75.2	2.96	45.5	1.79	41.0	1.61	28.0	1.10
Ⓢ K6-M-E-36N07	K8-M-E-36N07	1-1/4	36	40	1-1/4	18.0	0.71	31.8	1.25	123.3	4.85	59.4	2.34	90.5	3.56	57.0	2.24	51.0	2.01	36.0	1.42
Ⓢ K6-M-E-48N09	K8-M-E-48N09	2	48	50	1-1/2	19.0	0.75	47.8	1.88	144.0	5.67	63.3	2.49	100.6	3.96	68.0	2.68	70.0	2.76	55.0	2.17

**PG
THREAD**

Order No.	Order No.	THD	Fits to Conduit			A		B		L		R		W		OD1		OD2		SP	
			IP66	IP68	PG	NW	mm	in	mm	in	mm	in	mm	in	mm	in	mm	in	mm	in	mm
Ⓢ K6-M-E-07P07	K8-M-E-07P07	7	7	10	1/4	11.0	0.43	6.5	0.26	58.5	2.30	31.2	1.23	41.7	1.64	17.0	0.67	18.0	0.71	9.5	0.37
Ⓢ K6-M-E-07P09	K8-M-E-07P09	9	7	10	1/4	11.0	0.43	6.5	0.26	59.5	2.34	31.2	1.23	41.7	1.64	17.0	0.67	20.0	0.79	9.5	0.37
Ⓢ K6-M-E-07P11	K8-M-E-07P11	11	7	10	1/4	11.0	0.43	6.5	0.26	61.0	2.40	31.2	1.23	41.7	1.64	17.0	0.67	23.0	0.91	9.5	0.37
Ⓢ K6-M-E-07P13	K8-M-E-07P13	13.5	7	10	1/4	11.0	0.43	6.5	0.26	62.5	2.46	31.2	1.23	41.7	1.64	17.0	0.67	26.0	1.02	9.5	0.37
Ⓢ K6-M-E-10P07	K8-M-E-10P07	7	10	12	5/16	11.0	0.43	6.5	0.26	59.5	2.34	31.2	1.23	43.0	1.69	20.0	0.79	18.0	0.71	9.5	0.37
Ⓢ K6-M-E-10P09	K8-M-E-10P09	9	10	12	5/16	11.0	0.43	10.0	0.39	60.5	2.38	31.2	1.23	43.0	1.69	20.0	0.79	20.0	0.79	13.0	0.51
Ⓢ K6-M-E-10P11	K8-M-E-10P11	11	10	12	5/16	11.0	0.43	10.0	0.39	62.0	2.44	31.2	1.23	43.0	1.69	20.0	0.79	23.0	0.91	13.0	0.51
Ⓢ K6-M-E-10P13	K8-M-E-10P13	13.5	10	12	5/16	11.0	0.43	10.0	0.39	63.5	2.50	31.2	1.23	43.0	1.69	20.0	0.79	26.0	1.02	13.0	0.51
Ⓢ K6-M-E-12P09	K8-M-E-12P09	9	12	16	3/8	11.0	0.43	10.0	0.39	63.0	2.48	31.7	1.25	45.7	1.80	24.0	0.94	20.0	0.79	14.0	0.55
Ⓢ K6-M-E-12P11	K8-M-E-12P11	11	12	16	3/8	11.0	0.43	12.0	0.47	64.4	2.54	31.7	1.25	45.7	1.80	24.0	0.94	23.0	0.91	15.0	0.59
Ⓢ K6-M-E-12P13	K8-M-E-12P13	13.5	12	16	3/8	11.0	0.43	12.0	0.47	66.0	2.60	31.7	1.25	45.7	1.80	24.0	0.94	26.0	1.02	15.0	0.59
Ⓢ K6-M-E-17P13	K8-M-E-17P13	13.5	17	20	1/2	12.0	0.47	13.8	0.54	75.0	2.95	36.6	1.44	55.2	2.17	30.0	1.18	26.0	1.02	17.0	0.67
Ⓢ K6-M-E-17P16	K8-M-E-17P16	16	17	20	1/2	12.0	0.47	16.4	0.65	76.0	2.99	36.6	1.44	55.2	2.17	30.0	1.18	28.0	1.10	20.0	0.79
Ⓢ K6-M-E-23P21	K8-M-E-23P21	21	23	25	3/4	12.0	0.47	21.7	0.85	90.0	3.54	41.5	1.63	61.2	2.41	38.0	1.50	35.0	1.38	26.0	1.02
Ⓢ K6-M-E-29P29	K8-M-E-29P29	29	29	32	1	13.0	0.51	29.1	1.15	102.8	4.05	47.5	1.87	71.0	2.80	45.5	1.79	44.0	1.73	32.0	1.26
Ⓢ K6-M-E-36P36	K8-M-E-36P36	36	36	40	1-1/4	13.0	0.51	36.0	1.42	125.0	4.92	59.4	2.34	85.5	3.37	57.0	2.24	55.0	2.17	40.0	1.57
Ⓢ K6-M-E-48P48	K8-M-E-48P48	48	48	50	1-1/2	13.0	0.51	47.8	1.88	144.0	5.67	63.3	2.49	94.7	3.73	68.0	2.68	70.0	2.76	55.0	2.17

**UL
LISTED****BBN** UL Listed, 90° Elbow, Polyamide Connector

Order No.	THD	Fits to Conduit			A		B		L		R		W		OD1		OD2		SP	
		NEMA 4X	NPT	NW	mm	in	mm	in	mm	in	mm	in	mm	in	mm	in	mm	in	mm	in
6BBN17N03	1/2	17	20	1/2	13.5	0.53	13.8	0.54	75.5	2.97	36.6	1.44	56.2	2.21	30.0	1.18	27.0	1.06	17.0	0.67
6BBN23N04	3/4	23	25	3/4	14.0	0.55	18.0	0.71	89.5	3.52	41.5	1.63	63.2	2.49	38.0	1.50	34.0	1.34	22.0	0.87
6BBN29N05	1	29	32	1	17.3	0.68	23.7	0.93	101.3	3.99	47.5	1.87	75.2	2.96	45.5	1.79	41.0	1.61	28.0	1.10
6BBN36N06	1-1/4	36	40	1-1/4	18.0	0.71	31.8	1.25	123.3	4.85	59.4	2.34	90.5	3.56	57.0	2.24	51.0	2.01	36.0	1.42
6BBN48N08	2	48	50	1-1/2	19.0	0.75	47.8	1.88	144.0	5.67	63.3	2.49	100.6	3.96	68.0	2.68	70.0	2.76	55.0	2.17



NPT
THREAD

Order No.	Order No.	THD	Fits to Conduit			A		B		L		R		W		OD1		OD2	
			IP66	IP68	NPT	NW	mm	in	mm	in	mm	in	mm	in	mm	in	mm	in	mm
Ⓢ K6-M-F-12N02	K8-M-F-12N02	1/2	12	16	3/8	11.0	0.43	12.0	0.47	59.8	2.35	31.6	1.24	25.3	1.00	24.0	0.94	27.0	1.06
Ⓢ K6-M-F-17N02	K8-M-F-17N02	1/2	17	20	1/2	13.5	0.53	13.8	0.54	65.5	2.58	37.6	1.48	29.5	1.16	30.0	1.18	27.0	1.06
Ⓢ K6-M-F-23N04	K8-M-F-23N04	3/4	23	25	3/4	14.0	0.55	18.0	0.71	79.7	3.14	41.5	1.63	36.6	1.44	38.0	1.50	34.0	1.34
Ⓢ K6-M-F-29N06	K8-M-F-29N06	1	29	32	1	17.3	0.68	23.7	0.93	88.8	3.50	47.5	1.87	44.0	1.73	45.5	1.79	41.0	1.61
Ⓢ K6-M-F-36N07	K8-M-F-36N07	1-1/4	36	40	1-1/4	18.0	0.71	31.8	1.25	103.6	4.08	59.4	2.34	54.6	2.15	57.0	2.24	51.0	2.01
Ⓢ K6-M-F-48N09	K8-M-F-48N09	2	48	50	1-1/2	19.0	0.75	47.8	1.88	124.4	4.90	63.3	2.49	68.5	2.70	68.0	2.68	70.0	2.76

PG
THREAD

Order No.	Order No.	THD	Fits to Conduit			A		B		L		R		W		OD1		OD2	
			IP66	IP68	PG	NW	mm	in	mm	in	mm	in	mm	in	mm	in	mm	in	mm
K6-M-F-10P07	K8-M-F-10P07	7	10	12	5/16	11.0	0.43	6.5	0.26	52.0	2.05	31.2	1.23	20.2	0.80	20.0	0.79	18.0	0.71
K6-M-F-10P09	K8-M-F-10P09	9	10	12	5/16	11.0	0.43	10.0	0.39	53.2	2.09	31.2	1.23	20.9	0.82	20.0	0.79	20.0	0.79
K6-M-F-10P11	K8-M-F-10P11	11	10	12	5/16	11.0	0.43	10.0	0.39	54.3	2.14	31.2	1.23	22.0	0.87	20.0	0.79	23.0	0.91
K6-M-F-10P13	K8-M-F-10P13	13.5	10	12	5/16	11.0	0.43	10.0	0.39	55.0	2.17	31.2	1.23	23.0	0.91	20.0	0.79	26.0	1.02
Ⓢ K6-M-F-12P09	K8-M-F-12P09	9	12	16	3/8	11.0	0.43	10.0	0.39	57.2	2.25	31.6	1.24	23.3	0.92	24.0	0.94	20.0	0.79
Ⓢ K6-M-F-12P11	K8-M-F-12P11	11	12	16	3/8	11.0	0.43	12.0	0.47	58.4	2.30	31.6	1.24	24.4	0.96	24.0	0.94	23.0	0.91
Ⓢ K6-M-F-12P13	K8-M-F-12P13	13.5	12	16	3/8	11.0	0.43	12.0	0.47	59.0	2.32	31.6	1.24	25.4	1.00	24.0	0.94	26.0	1.02
Ⓢ K6-M-F-17P13	K8-M-F-17P13	13.5	17	20	1/2	12.0	0.47	13.8	0.54	65.3	2.57	37.6	1.48	29.5	1.16	30.0	1.18	26.0	1.02
Ⓢ K6-M-F-17P16	K8-M-F-17P16	16	17	20	1/2	12.0	0.47	16.4	0.65	66.0	2.60	37.6	1.48	30.3	1.19	30.0	1.18	28.0	1.10
Ⓢ K6-M-F-23P21	K8-M-F-23P21	21	23	25	3/4	12.0	0.47	21.8	0.86	79.5	3.13	41.5	1.63	37.0	1.46	38.0	1.50	35.0	1.38
Ⓢ K6-M-F-29P29	K8-M-F-29P29	29	29	32	1	13.0	0.51	29.1	1.15	88.2	3.47	47.5	1.87	45.0	1.77	45.5	1.79	44.0	1.73
Ⓢ K6-M-F-36P36	K8-M-F-36P36	36	36	40	1-1/4	13.0	0.51	36.0	1.42	102.6	4.04	59.4	2.34	56.3	2.22	57.0	2.24	55.0	2.17
Ⓢ K6-M-F-48P48	K8-M-F-48P48	48	48	50	1-1/2	13.0	0.51	47.8	1.88	121.0	4.76	63.3	2.49	68.5	2.70	68.0	2.68	70.0	2.76

UL
LISTED

BBF

UL Listed, 45° Elbow, Polyamide Connector



Order No.	THD	Fits to Conduit			A		B		L		R		W		OD1		OD2	
		NEMA 4X	NPT	NW	mm	in	mm	in	mm	in	mm	in	mm	in	mm	in	mm	in
6BBF17N03	1/2	17	20	1/2	13.5	0.53	13.8	0.54	65.5	2.58	37.6	1.48	29.5	1.16	30.0	1.18	27.0	1.06
6BBF23N04	3/4	23	25	3/4	14.0	0.55	18.0	0.71	79.7	3.14	41.5	1.63	36.6	1.44	38.0	1.50	34.0	1.34
6BBF29N05	1	29	32	1	17.3	0.68	23.7	0.93	88.8	3.50	47.5	1.87	44.0	1.73	45.5	1.79	41.0	1.61
6BBF36N06	1-1/4	36	40	1-1/4	18.0	0.71	31.8	1.25	103.6	4.08	59.4	2.34	54.6	2.15	57.0	2.24	51.0	2.01
6BBF48N08	2	48	50	1-1/2	19.0	0.75	47.8	1.88	124.4	4.90	63.3	2.49	68.5	2.70	68.0	2.68	70.0	2.76

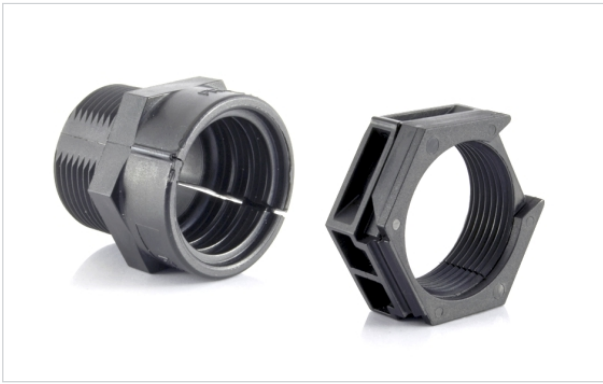

- Specially formulated polyamide
- To be used with divisible conduit types **PMD** and **NMD**, Page 12
- Self-extinguishing, free from halogens and cadmium
- Very good impact strength
- Temperature range: -40°C(-40°F) to 100°C(212°F)
- Short-term to 130°C(266°F)
- Up to IP50 Protection
- Colour: Black

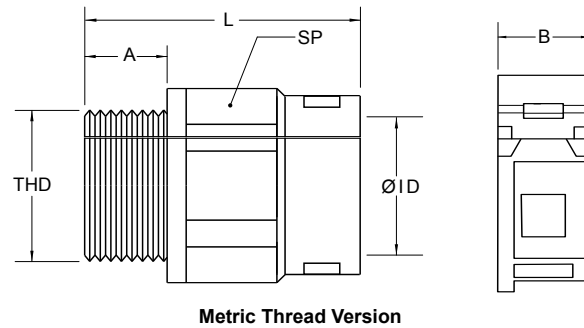
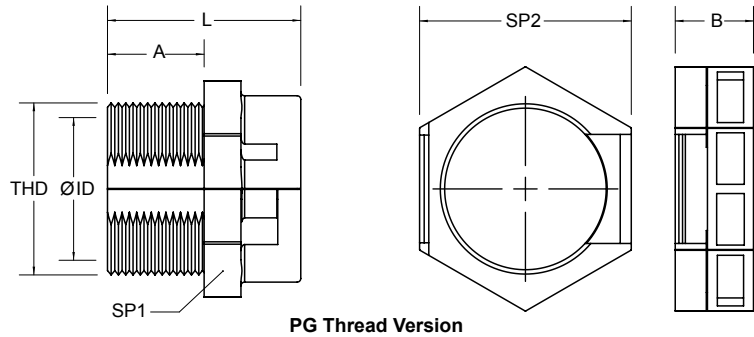
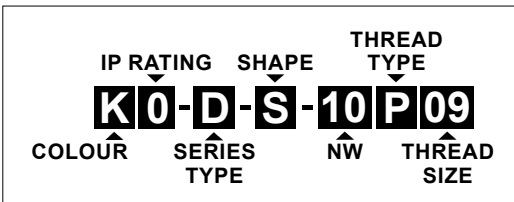

Specifications are subject to change without notice

**PG
THREAD**

Order No.	THD	Fits to	Ø ID		A		L		B		SP1		SP2	
			mm	in	mm	in	mm	in	mm	in	mm	in	mm	in
K0-D-S10P09	9	10	9.0	0.35	12.0	0.47	27.0	1.06	11.0	0.43	19.0	0.75	22.0	0.87
K0-D-S14P13	13.5	14	13.0	0.51	17.0	0.67	34.0	1.34	14.0	0.55	24.0	0.94	30.0	1.18
K0-D-S20P21	21	20	20.0	0.79	17.0	0.67	34.0	1.34	14.0	0.55	32.0	1.26	36.0	1.42
K0-D-S23P29	29	23	31.0	1.22	21.0	0.83	42.0	1.65	17.0	0.67	41.0	1.61	46.0	1.81
K0-D-S37P29	29	37	31.0	1.22	22.0	0.87	50.0	1.97	17.0	0.67	50.0	1.97	55.0	2.17

**METRIC
THREAD**

Order No.	THD	Fits to	Ø ID		A		L		B		SP	
			mm	in	mm	in	mm	in	mm	in	mm	in
K0-D-S-10M16	M16x1.5	10	13.9	0.55	11.0	0.43	34.0	1.34	8.0	0.31	19.0	0.75
K0-D-S-14M20	M20x1.5	14	19.0	0.75	11.0	0.43	41.0	1.61	8.0	0.31	27.0	1.06
K0-D-S-20M25	M25x1.5	20	26.2	1.03	12.0	0.47	43.0	1.69	9.0	0.35	32.0	1.26
K0-D-S-23M32	M32x1.5	23	31.8	1.25	15.0	0.59	50.5	1.99	12.0	0.47	40.0	1.57
K0-D-S-37M40	M40x1.5	37	42.0	1.65	19.0	0.75	59.0	2.32	15.0	0.59	48.0	1.89
K0-D-S-45M50	M50x1.5	45	55.0	2.17	19.0	0.75	67.5	2.66	15.0	0.59	64.0	2.52



- Locking device system provides a quick and secure push-in connection of corrugated conduits
- High-grade formulated polyamide, with black anodized aluminum thread
- Self-extinguishing, free from halogens and cadmium
- Excellent impact strength
- Temperature range: -40°C(-40°F) to 105°C(221°F)
- Short-term to 160°C(320°F)
- Up to IP68 / NEMA 6P protection with the reinforced sealing cap at conduit side
- Colour: Black standard, other colours available upon request

TEAFLEX

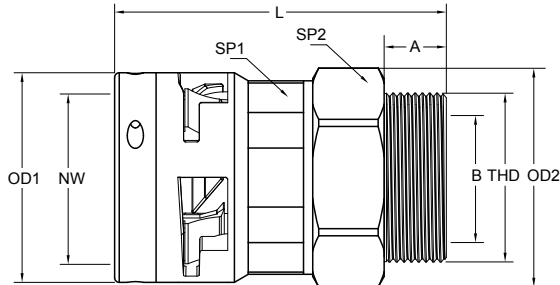

IP RATING SHAPE THREAD TYPE
L 8-MS-S-12M16
 COLOUR MATERIAL SERIES TYPE NW THREAD SIZE

Specifications are subject to change without notice

Order No. IP66	Order No. IP68	THD Metric	Fits to Conduit			A		B		L		OD1		OD2		SP1		SP2	
			NW	mm	in	mm	in	mm	in	mm	in	mm	in	mm	in	mm	in	mm	in
L6-MS-S-10M12	L8-MS-S-10M12	M12x1.5	10	12	5/16	11.0	0.43	7.0	0.28	53.4	2.10	20.0	0.79	21.0	0.83	17.0	0.67	25.4	1.00
L6-MS-S-10M16	L8-MS-S-10M16	M16x1.5	10	12	5/16	11.0	0.43	11.2	0.44	53.4	2.10	20.0	0.79	28.0	1.10	17.0	0.67	25.4	1.00
L6-MS-S-12M16	L8-MS-S-12M16	M16x1.5	12	16	3/8	11.0	0.43	12.0	0.47	57.2	2.25	24.0	0.94	28.0	1.10	20.0	0.79	25.4	1.00
L6-MS-S-12M20	L8-MS-S-12M20	M20x1.5	12	16	3/8	12.0	0.47	12.0	0.47	59.3	2.33	24.0	0.94	28.0	1.10	20.0	0.79	25.4	1.00
L6-MS-S-17M20	L8-MS-S-17M20	M20x1.5	17	20	1/2	12.0	0.47	15.5	0.61	59.4	2.34	30.0	1.18	35.0	1.38	26.0	1.02	31.8	1.25
L6-MS-S-17M25	L8-MS-S-17M25	M25x1.5	17	20	1/2	12.0	0.47	16.2	0.64	59.4	2.34	30.0	1.50	35.0	1.38	26.0	1.02	31.8	1.25
L6-MS-S-23M25	L8-MS-S-23M25	M25x1.5	23	25	3/4	12.0	0.47	20.0	0.79	68.5	2.70	38.0	1.50	42.0	1.65	32.0	1.26	38.1	1.50
L6-MS-S-23M32	L8-MS-S-23M32	M32x1.5	23	25	3/4	12.0	0.47	22.6	0.89	68.5	2.70	38.0	1.50	42.0	1.65	32.0	1.26	38.1	1.50
L6-MS-S-29M32	L8-MS-S-29M32	M32x1.5	29	32	1	13.5	0.53	27.0	1.06	72.0	2.83	45.5	1.79	49.0	1.93	40.0	1.57	44.5	1.75
L6-MS-S-36M40	L8-MS-S-36M40	M40x1.5	36	40	1-1/4	13.5	0.53	35.5	1.40	81.0	3.19	57.0	2.24	56.0	2.20	50.0	1.97	50.8	2.00
L6-MS-S-48M50	L8-MS-S-48M50	M50x1.5	48	50	1-1/2	14.5	0.57	45.0	1.77	92.0	3.62	68.0	2.68	70.0	2.76	64.0	2.52	63.5	2.50
L6-MS-S-48M63	L8-MS-S-48M63	M63x1.5	48	50	1-1/2	14.5	0.57	47.7	1.88	92.0	3.62	68.0	2.68	70.0	2.76	64.0	2.52	63.5	2.50

METRIC
METAL
THREAD

Order No. IP66	Order No. IP68	THD NPT	Fits to Conduit			A		B		L		OD1		OD2		SP1		SP2	
			NW	mm	in	mm	in	mm	in	mm	in	mm	in	mm	in	mm	in	mm	in
L6-MS-S-10N02	L8-MS-S-10N02	1/2	10	12	5/16	11.0	0.43	11.2	0.44	57.2	2.25	20.0	0.79	28.0	1.10	17.0	0.67	25.4	1.00
L6-MS-S-10N04	L8-MS-S-10N04	1/2	10	12	5/16	14.0	0.55	11.2	0.44	60.0	2.36	20.0	0.79	36.0	1.42	17.0	0.67	31.8	1.25
L6-MS-S-12N02	L8-MS-S-12N02	1/2	12	16	3/8	11.0	0.43	12.0	0.47	57.2	2.25	24.0	0.94	28.0	1.10	20.0	0.79	25.4	1.00
L6-MS-S-17N02	L8-MS-S-17N02	1/2	17	20	1/2	13.5	0.53	16.2	0.64	60.9	2.40	30.0	1.18	35.0	1.38	26.0	1.02	31.8	1.25
L6-MS-S-17N04	L8-MS-S-17N04	3/4	17	20	1/2	14.0	0.55	16.2	0.64	62.0	2.44	30.0	1.18	35.0	1.38	26.0	1.02	31.8	1.25
L6-MS-S-23N04	L8-MS-S-23N04	3/4	23	25	3/4	14.0	0.55	22.6	0.89	70.5	2.78	38.0	1.50	42.0	1.65	32.0	1.26	38.1	1.50
L6-MS-S-29N06	L8-MS-S-29N06	1	29	32	1	17.3	0.68	32.0	1.26	75.8	2.98	45.5	1.79	49.0	1.93	40.0	1.57	44.5	1.75
L6-MS-S-36N07	L8-MS-S-36N07	1-1/4	36	40	1-1/4	18.0	0.71	38.5	1.52	85.5	3.37	57.0	2.24	56.0	2.20	50.0	1.97	50.8	2.00
L6-MS-S-48N08	L8-MS-S-48N08	1-1/2	48	50	1-1/2	20.0	0.79	47.7	1.88	97.5	3.84	68.0	2.68	70.0	2.76	64.0	2.52	63.5	2.50
L6-MS-S-48N09	L8-MS-S-48N09	2	48	50	1-1/2	20.0	0.79	47.7	1.88	97.5	3.84	68.0	2.68	70.0	2.76	64.0	2.52	63.5	2.50

NPT
METAL
THREAD

Order No. IP66	Order No. IP68	THD PG	Fits to Conduit			A		B		L		OD1		OD2		SP1		SP2	
			NW	mm	in	mm	in	mm	in	mm	in	mm	in	mm	in	mm	in	mm	in
L6-MS-S-10P09	L8-MS-S-10P09	9	10	12	5/16	11.0	0.43	11.2	0.44	53.4	2.10	20.0	0.79	28.0	1.10	17.0	0.67	25.4	1.00
L6-MS-S-10P11	L8-MS-S-10P11	9	10	12	5/16	11.0	0.43	12.0	0.47	53.4	2.10	20.0	0.79	28.0	1.10	17.0	0.67	25.4	1.00
L6-MS-S-12P11	L8-MS-S-12P11	11	12	16	3/8	11.0	0.43	12.0	0.47	57.2	2.25	24.0	0.94	28.0	1.10	20.0	0.79	25.4	1.00
L6-MS-S-17P13	L8-MS-S-17P13	13.5	17	20	1/2	12.0	0.47	16.2	0.64	59.4	2.34	30.0	1.18	35.0	1.38	26.0	1.02	31.8	1.25
L6-MS-S-17P16	L8-MS-S-17P16	16	17	20	1/2	12.0	0.47	16.2	0.64	59.4	2.34	30.0	1.18	35.0	1.38	26.0	1.02	31.8	1.25
L6-MS-S-23P21	L8-MS-S-23P21	21	23	25	3/4	12.0	0.47	22.6	0.89	68.5	2.70	38.0	1.50	42.0	1.65	32.0	1.26	38.1	1.50
L6-MS-S-29P29	L8-MS-S-29P29	29	29	32	1	13.5	0.53	32.0	1.26	72.0	2.83	45.5	1.79	49.0	1.93	40.0	1.57	44.5	1.75
L6-MS-S-36P36	L8-MS-S-36P36	36	36	40	1-1/4	13.5	0.53	38.5	1.52	81.0	3.19	57.0	2.24	56.0	2.20	50.0	1.97	50.8	2.00
L6-MS-S-48P48	L8-MS-S-48P48	48	48	50	1-1/2	14.5	0.57	47.7	1.88	92.0	3.62	68.0	2.68	70.0	2.76	64.0	2.52	63.5	2.50

PG
METAL
THREAD

TEAFLEX



- Locking device system provides a quick and secure push-in connection of corrugated conduits
- High-grade formulated polyamide, with black anodized aluminum thread
- Self-extinguishing, free from halogens and cadmium
- Excellent impact strength
- Temperature range: -40°C(-40°F) to 105°C(221°F)
- Short-term to 160°C(320°F)
- Up to IP68 / NEMA 6P protection with the reinforced sealing cap at conduit side
- Colour: Black standard, other colours available upon request

IP RATING: **L8**
SHAPE: **MS-E**
THREAD TYPE: **12M16**
COLOUR MATERIAL: **L**
SERIES TYPE: **MS-E**
NW: **12**
THREAD SIZE: **16**

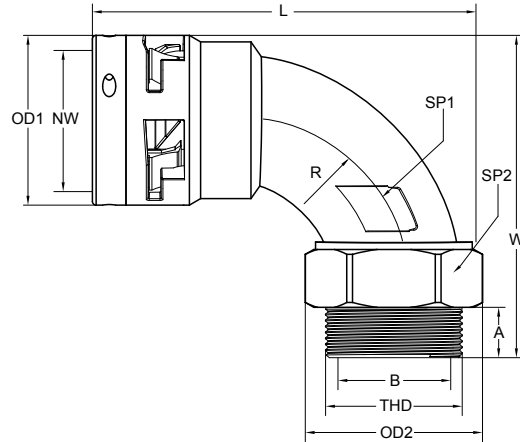

Specifications are subject to change without notice

METRIC METAL THREAD

Order No. IP66	Order No. IP68	THD Metric	Fits to Conduit			A		B		L		R		W		OD1		OD2		SP1		SP2	
			NW	mm	in	mm	in	mm	in	mm	in	mm	in	mm	in	mm	in	mm	in	mm	in	mm	in
L6-MS-E-10M12	L8-MS-E-10M12	M12x1.5	10	12	5/16	11.0	0.43	7.0	0.39	60.5	2.38	31.2	1.23	57.2	2.25	20.0	0.79	28.0	1.10	13.0	0.51	25.4	1.00
L6-MS-E-10M16	L8-MS-E-10M16	M16x1.5	10	12	5/16	11.0	0.43	10.0	0.39	60.5	2.38	31.2	1.23	57.2	2.25	20.0	0.79	28.0	1.10	13.0	0.51	25.4	1.00
L6-MS-E-12M16	L8-MS-E-12M16	M16x1.5	12	16	3/8	11.0	0.43	12.0	0.47	65.0	2.56	31.7	1.25	59.7	2.35	24.0	0.94	28.0	1.10	15.0	0.59	25.4	1.00
L6-MS-E-17M20	L8-MS-E-17M20	M20x1.5	17	20	1/2	12.0	0.47	15.5	0.61	76.0	2.99	36.6	1.44	69.2	2.72	30.0	1.18	35.0	1.38	20.0	0.79	31.8	1.25
L6-MS-E-17M25	L8-MS-E-17M25	M25x1.5	17	20	1/2	12.0	0.47	16.4	0.65	76.0	2.99	36.6	1.44	69.2	2.72	30.0	1.50	35.0	1.38	20.0	0.79	31.8	1.25
L6-MS-E-23M25	L8-MS-E-23M25	M25x1.5	23	25	3/4	12.0	0.47	21.7	0.85	90.0	3.54	41.5	1.63	75.2	2.96	38.0	1.50	42.0	1.65	26.0	1.02	38.1	1.50
L6-MS-E-23M32	L8-MS-E-23M32	M32x1.5	23	25	3/4	12.0	0.47	21.7	0.85	90.0	3.54	41.5	1.63	75.2	2.96	38.0	1.50	42.0	1.65	26.0	1.02	38.1	1.50
L6-MS-E-29M32	L8-MS-E-29M32	M32x1.5	29	32	1	13.5	0.53	29.1	1.15	101.8	4.01	47.5	1.87	86.4	3.40	45.5	1.79	49.0	1.93	32.0	1.26	44.5	1.75
L6-MS-E-36M40	L8-MS-E-36M40	M40x1.5	36	40	1-1/4	13.5	0.53	36.0	1.42	123.5	4.86	59.4	2.34	102.0	4.02	57.0	2.24	56.0	2.20	40.0	1.57	50.8	2.00
L6-MS-E-48M50	L8-MS-E-48M50	M50x1.5	48	50	1-1/2	14.5	0.57	45.0	1.77	142.4	5.61	63.3	2.49	115.2	4.54	68.0	2.68	70.0	2.76	55.0	2.17	63.5	2.50
L6-MS-E-48M63	L8-MS-E-48M63	M63x1.5	48	50	1-1/2	14.5	0.57	47.8	1.88	142.5	5.61	63.3	2.49	115.2	4.54	68.0	2.68	70.0	2.76	55.0	2.17	63.5	2.50

NPT METAL THREAD

Order No. IP66	Order No. IP68	THD NPT	Fits to Conduit			A		B		L		R		W		OD1		OD2		SP1		SP2	
			NW	mm	in	mm	in	mm	in	mm	in	mm	in	mm	in	mm	in	mm	in	mm	in	mm	in
L6-MS-E-12N02	L8-MS-E-12N02	1/2	12	16	3/8	11.0	0.43	12.0	0.47	65.0	2.56	31.7	1.25	59.7	2.35	24.0	0.94	28.0	1.10	15.0	0.59	25.4	1.00
L6-MS-E-17N02	L8-MS-E-17N02	1/2	17	20	1/2	13.5	0.53	16.4	0.65	76.0	2.99	36.6	1.44	69.2	2.72	30.0	1.18	35.0	1.38	20.0	0.79	31.8	1.25
L6-MS-E-23N04	L8-MS-E-23N04	3/4	23	25	3/4	14.0	0.55	21.7	0.85	90.0	3.54	41.5	1.63	75.2	2.96	38.0	1.50	42.0	1.65	26.0	1.02	38.1	1.50
L6-MS-E-29N06	L8-MS-E-29N06	1	29	32	1	17.3	0.68	29.1	1.15	101.8	4.01	47.5	1.87	86.4	3.40	45.5	1.79	49.0	1.93	32.0	1.26	44.5	1.75
L6-MS-E-36N07	L8-MS-E-36N07	1-1/4	36	40	1-1/4	18.0	0.71	36.0	1.42	123.5	4.86	59.4	2.34	102.0	4.02	57.0	2.24	56.0	2.20	40.0	1.57	50.8	2.00
L6-MS-E-48N08	L8-MS-E-48N08	1-1/2	48	50	1-1/2	20.0	0.79	47.8	1.88	143.5	5.65	63.3	2.49	122.0	4.80	68.0	2.68	70.0	2.76	55.0	2.17	63.5	2.50
L6-MS-E-48N09	L8-MS-E-48N09	2	48	50	1-1/2	20.0	0.79	47.8	1.88	143.5	5.65	63.3	2.49	122.0	4.80	68.0	2.68	70.0	2.76	55.0	2.17	63.5	2.50

PG METAL THREAD

Order No. IP66	Order No. IP68	THD PG	Fits to Conduit			A		B		L		R		W		OD1		OD2		SP1		SP2	
			NW	mm	in	mm	in	mm	in	mm	in	mm	in	mm	in	mm	in	mm	in	mm	in	mm	in
L6-MS-E-10P09	L8-MS-E-10P09	9	10	12	5/16	11.0	0.43	10.0	0.39	60.5	2.38	31.2	1.23	57.2	2.25	20.0	0.79	28.0	1.10	13.0	0.51	25.4	1.00
L6-MS-E-12P11	L8-MS-E-12P11	11	12	16	3/8	11.0	0.43	12.0	0.47	65.0	2.56	31.7	1.25	59.7	2.35	24.0	0.94	28.0	1.10	15.0	0.59	25.4	1.00
L6-MS-E-17P13	L8-MS-E-17P13	13.5	17	20	1/2	12.0	0.47	16.2	0.64	76.0	2.99	36.6	1.44	69.2	2.72	30.0	1.18	35.0	1.38	20.0	0.79	31.8	1.25
L6-MS-E-17P16	L8-MS-E-17P16	16	17	20	1/2	12.0	0.47	16.4	0.65	76.0	2.99	36.6	1.44	69.2	2.72	30.0	1.18	35.0	1.38	20.0	0.79	31.8	1.25
L6-MS-E-23P21	L8-MS-E-23P21	21	23	25	3/4	12.0	0.47	21.7	0.85	90.0	3.54	41.5	1.63	75.2	2.96	38.0	1.50	42.0	1.65	26.0	1.02	38.1	1.50
L6-MS-E-29P29	L8-MS-E-29P29	29	29	32	1	13.5	0.53	29.1	1.15	101.8	4.01	47.5	1.87	86.4	3.40	45.5	1.79	49.0	1.93	32.0	1.26	44.5	1.75
L6-MS-E-36P36	L8-MS-E-36P36	36	36	40	1-1/4	13.5	0.53	36.0	1.42	123.5	4.86	59.4	2.34	102.0	4.02	57.0	2.24	56.0	2.20	40.0	1.57	50.8	2.00
L6-MS-E-48P48	L8-MS-E-48P48	48	48	50	1-1/2	14.5	0.57	47.8	1.88	142.4	5.61	63.3	2.49	115.2	4.54	68.0	2.68	70.0	2.76	55.0	2.17	63.5	2.50



- Locking device system provides a quick and secure push-in connection of corrugated conduits
- High-grade formulated polyamide, with black anodized aluminum thread
- Self-extinguishing, free from halogens and cadmium
- Excellent impact strength
- Temperature range: -40°C(-40°F) to 105°C(221°F)
- Short-term to 160°C(320°F)
- Up to IP68 / NEMA 6P protection with the reinforced sealing cap at conduit side
- Colour: Black standard, other colours available upon request

TEAFLEX

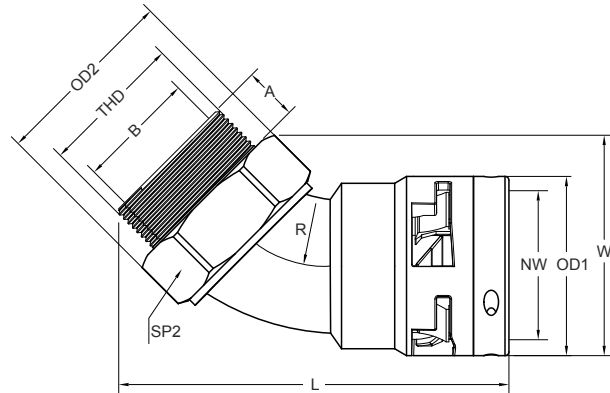
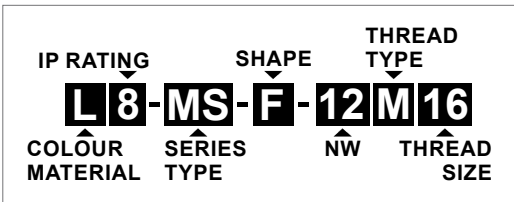

Specifications are subject to change without notice

Order No. IP66	Order No. IP68	THD Metric	Fits to Conduit			A		B		L		R		W		OD1		OD2		SP2	
			NW	mm	in	mm	in	mm	in	mm	in	mm	in	mm	in	mm	in	mm	in	mm	in
L6-MS-F-10M12	L8-MS-F-10M12	M12x1.5	10	12	5/16	11.0	0.43	7.0	0.28	62.5	2.46	31.2	1.23	32.0	1.26	20.0	0.79	28.0	1.10	25.4	1.00
L6-MS-F-10M16	L8-MS-F-10M16	M16x1.5	10	12	5/16	11.0	0.43	10.0	0.39	63.0	2.48	31.2	1.23	32.0	1.26	20.0	0.79	28.0	1.10	25.4	1.00
L6-MS-F-12M16	L8-MS-F-12M16	M16x1.5	12	16	3/8	11.0	0.43	12.0	0.47	67.0	2.64	31.6	1.24	35.0	1.38	24.0	0.94	28.0	1.10	25.4	1.00
L6-MS-F-17M20	L8-MS-F-17M20	M20x1.5	17	20	1/2	12.0	0.47	15.5	0.61	74.6	2.94	37.6	1.48	40.6	1.60	30.0	1.18	35.0	1.38	31.8	1.25
L6-MS-F-17M25	L8-MS-F-17M25	M25x1.5	17	20	1/2	12.0	0.47	16.4	0.65	74.6	2.94	37.6	1.48	40.6	1.60	30.0	1.18	35.0	1.38	31.8	1.25
L6-MS-F-23M25	L8-MS-F-23M25	M25x1.5	23	25	3/4	12.0	0.47	21.8	0.86	88.2	3.47	41.5	1.63	47.6	1.87	38.0	1.50	42.0	1.65	38.1	1.50
L6-MS-F-23M32	L8-MS-F-23M32	M32x1.5	23	25	3/4	12.0	0.47	21.8	0.86	88.2	3.47	41.5	1.63	47.6	1.87	38.0	1.50	42.0	1.65	38.1	1.50
L6-MS-F-29M32	L8-MS-F-29M32	M32x1.5	29	32	1	13.5	0.53	29.1	1.15	97.0	3.82	47.5	1.87	56.0	2.20	45.5	1.79	49.0	1.93	44.5	1.75
L6-MS-F-36M40	L8-MS-F-36M40	M40x1.5	36	40	1-1/4	13.5	0.53	36.0	1.42	111.5	4.39	59.4	2.34	68.0	2.68	57.0	2.24	56.0	2.20	50.8	2.00
L6-MS-F-48M50	L8-MS-F-48M50	M50x1.5	48	50	1-1/2	14.5	0.57	45.0	1.77	131.6	5.18	63.3	2.49	81.6	3.21	68.0	2.68	70.0	2.76	63.5	2.50
L6-MS-F-48M63	L8-MS-F-48M63	M63x1.5	48	50	1-1/2	14.5	0.57	47.8	1.88	136.5	5.37	63.3	2.49	82.8	3.26	68.0	2.68	70.0	2.76	63.5	2.50

METRIC METAL THREAD

Order No. IP66	Order No. IP68	THD NPT	Fits to Conduit			A		B		L		R		W		OD1		OD2		SP2	
			NW	mm	in	mm	in	mm	in	mm	in	mm	in	mm	in	mm	in	mm	in	mm	in
L6-MS-F-12N02	L8-MS-F-12N02	1/2	12	16	3/8	11.0	0.43	12.0	0.47	68.2	2.69	31.6	1.24	35.0	1.38	24.0	0.94	27.0	1.06	25.4	1.00
L6-MS-F-17N02	L8-MS-F-17N02	1/2	17	20	1/2	13.5	0.53	16.4	0.65	75.9	2.99	37.6	1.48	40.6	1.60	30.0	1.18	31.0	1.22	31.8	1.25
L6-MS-F-23N04	L8-MS-F-23N04	3/4	23	25	3/4	14.0	0.55	21.8	0.86	89.6	3.53	41.5	1.63	47.6	1.87	38.0	1.50	39.5	1.56	38.1	1.50
L6-MS-F-29N06	L8-MS-F-29N06	1	29	32	1	17.3	0.68	29.1	1.15	99.0	3.90	47.5	1.87	56.0	2.20	45.5	1.79	47.5	1.87	44.5	1.75
L6-MS-F-36N07	L8-MS-F-36N07	1-1/4	36	40	1-1/4	18.0	0.71	36.0	1.42	114.3	4.50	59.4	2.34	68.0	2.68	57.0	2.24	58.0	2.28	50.8	2.00
L6-MS-F-48N08	L8-MS-F-48N08	1-1/2	48	50	1-1/2	20.0	0.75	47.8	1.88	136.0	5.35	63.3	2.49	81.6	3.21	68.0	2.68	72.5	2.85	63.5	2.50
L6-MS-F-48N09	L8-MS-F-48N09	2	48	50	1-1/2	20.0	0.75	47.8	1.88	136.0	5.35	63.3	2.49	81.6	3.21	68.0	2.68	72.5	2.85	63.5	2.50

NPT METAL THREAD

Order No. IP66	Order No. IP68	THD PG	Fits to Conduit			A		B		L		R		W		OD1		OD2		SP2	
			NW	mm	in	mm	in	mm	in	mm	in	mm	in	mm	in	mm	in	mm	in	mm	in
L6-MS-F-10P09	L8-MS-F-10P09	9	10	12	5/16	11.0	0.43	10.0	0.39	63.0	2.48	31.2	1.23	32.0	1.26	20.0	0.79	28.0	1.10	25.4	0.75
L6-MS-F-12P11	L8-MS-F-12P11	11	12	16	3/8	11.0	0.43	12.0	0.47	68.2	2.69	31.6	1.24	35.0	1.38	24.0	0.94	28.0	1.10	25.4	1.00
L6-MS-F-17P13	L8-MS-F-17P13	13.5	17	20	1/2	12.0	0.47	16.2	0.64	74.8	2.94	37.6	1.48	40.6	1.60	30.0	1.18	35.0	1.38	31.8	1.25
L6-MS-F-17P16	L8-MS-F-17P16	16	17	20	1/2	12.0	0.47	16.4	0.65	75.9	2.99	37.6	1.48	40.6	1.60	30.0	1.18	35.0	1.38	31.8	1.25
L6-MS-F-23P21	L8-MS-F-23P21	21	23	25	3/4	12.0	0.47	21.8	0.86	89.6	3.53	41.5	1.63	47.6	1.87	38.0	1.50	42.0	1.65	38.1	1.50
L6-MS-F-29P29	L8-MS-F-29P29	29	29	32	1	13.5	0.53	29.1	1.15	99.0	3.90	47.5	1.87	56.0	2.20	45.5	1.79	49.0	1.93	44.5	1.75
L6-MS-F-36P36	L8-MS-F-36P36	36	36	40	1-1/4	13.5	0.53	36.0	1.42	114.3	4.50	59.4	2.34	68.0	2.68	57.0	2.24	56.0	2.20	50.8	2.00
L6-MS-F-48P48	L8-MS-F-48P48	48	48	50	1-1/2	14.5	0.57	47.8	1.88	135.0	5.31	63.3	2.49	81.6	3.21	68.0	2.68	70.0	2.76	63.5	2.50

PG METAL THREAD

TEAFLEX



- Locking device system provides a quick and secure push-in connection of corrugated conduits
- High-grade formulated polyamide, with (TPE) Tubular Sealing Insert
- Self-extinguishing, free from halogens and cadmium
- Excellent impact strength
- Temperature range: -40°C(-40°F) to 105°C(221°F)
- Short-term to 160°C(320°F)
- Up to IP68 / NEMA 6P protection with the reinforced sealing cap at conduit side
- Colour: Black standard, other colours available upon request

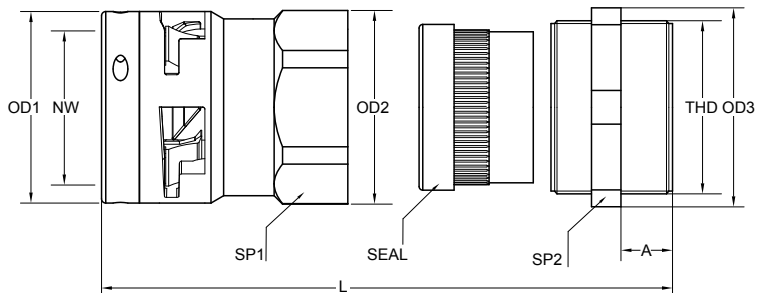
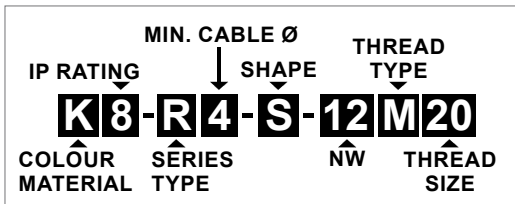

Specifications are subject to change without notice

**METRIC
THREAD**

Order No.	THD		Fits to Conduit		Cable Range		Seal		A		L		OD1		OD2		OD3		SP1		SP2	
	IP68	Metric	NW	mm	in	mm	mm	Colour	mm	in	mm	in	mm	in	mm	in	mm	in	mm	in	mm	in
K8-R4-S-10M16						4 - 6.5	Yellow															
K8-R5-S-10M16		M16x1.5	10	12	5/16	5 - 8	Grey	9.0	0.35	53.4	2.10	20.0	0.79	22.0	0.87	21.0	0.83	20.0	0.79	19.0	0.75	
K8-R6.5-S-10M16						6.5 - 9.5	Black															
K8-R4-S-12M20						4 - 6.5	Yellow															
K8-R5-S-12M20						5 - 8	Grey															
K8-R6.5-S-12M20		M20x1.5	12	16	3/8	6.5 - 9.5	Black	9.0	0.35	57.2	2.25	24.0	0.94	29.0	1.14	26.8	1.06	26.0	1.02	24.0	0.94	
K8-R7-S-12M20						7 - 10.5	Green															
K8-R9-S-12M20						9 - 13	Red															
K8-R4-S-17M20						4 - 6.5	Yellow															
K8-R5-S-17M20						5 - 8	Grey															
K8-R6.5-S-17M20		M20x1.5	17	20	1/2	6.5 - 9.5	Black	9.0	0.35	58.4	2.30	30.0	1.18	29.0	1.14	26.8	1.06	26.0	1.02	24.0	0.94	
K8-R7-S-17M20						7 - 10.5	Green															
K8-R9-S-17M20						9 - 13	Red															
K8-R7-S-23M25						7 - 10.5	Green															
K8-R9-S-23M25						9 - 13	Red															
K8-R11.5-S-23M25		M25x1.5	23	25	3/4	11.5 - 15.5	White	11.0	0.43	78.0	3.07	38.0	1.50	38.0	1.50	36.8	1.45	34.0	1.34	33.0	1.30	
K8-R14-S-23M25						14 - 18	Blue															
K8-R17-S-23M25						17 - 20.5	Brown															
K8-R11.5-S-23M32						11.5 - 15.5	White															
K8-R14-S-23M32		M32x1.5	23	25	3/4	14 - 18	Blue	11.0	0.43	82.5	3.25	38.0	1.50	46.0	1.81	46.5	1.83	42.0	1.65	43.0	1.69	
K8-R17-S-23M32						17 - 20.5	Brown															
K8-R14-S-29M32						14 - 18	Blue															
K8-R17-S-29M32		M32x1.5	29	32	1	17 - 20.5	Brown	11.0	0.43	82.5	3.25	45.5	1.79	46.0	1.81	46.5	1.83	42.0	1.65	43.0	1.69	
K8-R20-S-29M32						20 - 25	Orange															
K8-R24-S-29M32						24 - 28	Light yellow															
K8-R27-S-36M40						27 - 32	Anthracite															
K8-R29-S-36M40		M40x1.5	36	40	1-1/4	29 - 34	Light Blue	14.0	0.55	95.0	3.74	57.0	2.24	61.0	2.40	57.8	2.28	55.0	2.17	54.0	2.13	
K8-R32-S-36M40						32 - 36	Pink															
K8-R27-S-36M50						27 - 32	Anthracite															
K8-R29-S-36M50		M50x1.5	36	40	1-1/4	29 - 34	Light Blue	14.0	0.55	90.0	3.54	57.0	2.24	61.0	2.40	57.8	2.28	55.0	2.17	54.0	2.13	
K8-R32-S-36M50						32 - 36	Pink															



PG
THREAD

Order No.	THD	Fits to Conduit			Cable Range	Seal Colour	A		L		OD1		OD2		OD3		SP1		SP2			
		IP68	NPT	NW			mm	in	mm	in	mm	in	mm	in	mm	in	mm	in	mm	in	mm	in
K8-R4-S-12N01	3/8	12	16	3/8	4 - 6.5	Yellow	13.0	0.51	61.0	2.40	24.0	0.94	27.0	1.06	28.0	1.10	24.0	0.94	25.4	1.00		
K8-R5-S-12N01					5 - 8	Grey																
K8-R6.5-S-12N01					6.5 - 9.5	Black																
K8-R7-S-12N01					7 - 10.5	Green																
K8-R4-S-17N02	1/2	17	20	1/2	4 - 6.5	Yellow	13.5	0.53	64.5	2.54	30.0	1.18	30.0	1.18	28.0	1.10	27.0	1.06	25.4	1.00		
K8-R5-S-17N02					5 - 8	Grey																
K8-R6.5-S-17N02					6.5 - 9.5	Black																
K8-R7-S-17N02					7 - 10.5	Green																
K8-R9-S-17N02					9 - 13	Red																
K8-R11.5-S-17N02					11.5 - 15.5	White																
K8-R7-S-23N04	3/4	23	25	3/4	7 - 10.5	Green	15.0	0.59	78.0	3.07	38.0	1.50	38.0	1.50	34.0	1.34	34.0	1.34	31.8	1.25		
K8-R9-S-23N04					9 - 13	Red																
K8-R11.5-S-23N04					11.5 - 15.5	White																
K8-R14-S-23N04					14 - 18	Blue																
K8-R17-S-23N04	17 - 20.5	Brown	1	29	32	1	11.5 - 15.5	White	20.0	0.79	86.0	3.39	45.5	1.79	46.0	1.81	48.0	1.89	42.0	1.65	44.5	1.75
K8-R14-S-29N06	14 - 18	Blue																				
K8-R17-S-29N06	17 - 20.5	Brown																				
K8-R20-S-29N06	20 - 25	Orange																				
K8-R24-S-29N06	24 - 28	Light Yellow																				
K8-R27-S-36N07	27 - 32	Anthracite																				
K8-R29-S-36N07	29 - 34	Light Blue	1-1/4	36	40	1-1/4	29 - 34	Light Blue	20.0	0.79	86.0	3.39	57.0	2.24	61.0	2.40	55.0	2.17	55.0	2.17	50.8	2.00
K8-R32-S-36N07	32 - 36	Pink																				
K8-R39-S-48N09	39 - 44	White					1- 1/2	48														

PG
THREAD

Order No.	THD	Fits to Conduit			Cable Range	Seal Colour	A		L		OD1		OD2		OD3		SP1		SP2			
		IP68	PG	NW			mm	in	mm	in	mm	in	mm	in	mm	in	mm	in	mm	in	mm	in
K8-R4-S-07P07	7	7	10	1/4	4 - 6.5	Yellow	8.0	0.31	50.5	1.99	17.0	0.67	19.0	0.75	18.0	0.71	17.0	0.67	16.0	0.63		
K8-R4-S-10P07	7	10	12	5/16	4 - 6.5	Yellow	8.0	0.31	51.9	2.04	20.0	0.79	19.0	0.75	18.0	0.71	17.0	0.67	16.0	0.63		
K8-R4-S-10P09	9	10	12	5/16	4 - 6.5	Yellow	9.0	0.35	53.4	2.10	20.0	0.79	22.0	0.87	21.0	0.83	20.0	0.79	19.0	0.75		
K8-R5-S-10P09					5 - 8	Grey																
K8-R6.5-S-10P09					6.5 - 9.5	Black																
K8-R4-S-12P11	11	12	16	3/8	4 - 6.5	Yellow	9.0	0.35	57.3	2.25	24.0	0.94	27.0	1.06	24.5	0.96	24.0	0.94	22.0	0.87		
K8-R5-S-12P11					5 - 8	Grey																
K8-R6.5-S-12P11					6.5 - 9.5	Black																
K8-R7-S-12P11					7 - 10.5	Green																
K8-R4-S-12P13	13.5	12	16	3/8	4 - 6.5	Yellow	9.0	0.35	57.2	0.35	24.0	0.35	29.0	0.35	26.8	0.35	26.0	0.35	24.0	0.35		
K8-R5-S-12P13					5 - 8	Grey																
K8-R6.5-S-12P13					6.5 - 9.5	Black																
K8-R7-S-12P13					7 - 10.5	Green																
K8-R9-S-12P13					9 - 13	Red																
K8-R4-S-17P13	13.5	17	20	1/2	4 - 6.5	Yellow	9.0	0.35	58.4	0.35	30.0	0.35	29.0	0.35	26.8	0.35	26.0	0.35	24.0	0.35		
K8-R5-S-17P13					5 - 8	Grey																
K8-R6.5-S-17P13					6.5 - 9.5	Black																
K8-R7-S-17P13					7 - 10.5	Green																
K8-R9-S-17P13					9 - 13	Red																
K8-R4-S-17P16	16	17	20	1/2	4 - 6.5	Yellow	9.5	0.37	57.9	2.28	30.0	1.18	30.0	1.18	29.8	1.17	27.0	1.06	27.0	1.06		
K8-R5-S-17P16					5 - 8	Grey																
K8-R6.5-S-17P16					6.5 - 9.5	Black																
K8-R7-S-17P16					7 - 10.5	Green																
K8-R9-S-17P16					9 - 13	Red																
K8-R11.5-S-17P16					11.5 - 15.5	White																
K8-R7-S-23P21	21	23	25	3/4	7 - 10.5	Green	11.0	0.43	74.0	2.91	38.0	1.50	38.0	1.50	36.8	1.45	34.0	1.34	33.0	1.30		
K8-R9-S-23P21					9 - 13	Red																
K8-R11.5-S-23P21					11.5 - 15.5	White																
K8-R14-S-23P21					14 - 18	Blue																
K8-R17-S-23P21	17 - 20.5	Brown	1	29	32	1	11.5 - 15.5	White	11.5	0.45	78.0	3.07	38.0	1.50	46.0	1.81	46.5	1.83	42.0	1.65	43.0	1.69
K8-R11.5-S-23P29	14 - 18	Blue																				
K8-R14-S-23P29	17 - 20.5	Brown																				
K8-R14-S-29P29	14 - 18	Blue																				
K8-R17-S-29P29	17 - 20.5	Brown																				
K8-R20-S-29P29	20 - 25	Orange																				
K8-R24-S-29P29	24 - 28	Light Yellow	36	36	40	1-1/4	27 - 32	Anthracite	14.0	0.55	90.0	3.54	57.0	2.24	61.0	2.40	57.8	2.28	55.0	2.17	54.0	2.13
K8-R27-S-36P36	29 - 34	Light Blue																				
K8-R29-S-36P36	32 - 36	Pink																				
K8-R32-S-36P36	39 - 44	White	1-1/2	48	50	1-1/2	39 - 44	White	14.0	0.55	99.5	3.92	68.0	2.68	76.0	2.99	72.0	2.83	70.0	2.76	67.0	2.64

TEAFLEX



- Locking device system provides a quick and secure push-in connection of corrugated conduits
- High-grade formulated polyamide, with electroless nickel plated brass thread
- Self-extinguishing, free from halogens and cadmium
- Excellent impact strength
- Temperature range: -40°C(-40°F) to 105°C(221°F)
- Short-term to 160°C(320°F)
- Up to IP68 / NEMA 6P protection with the reinforced sealing cap at conduit side
- Colour: Black standard, other colours available upon request

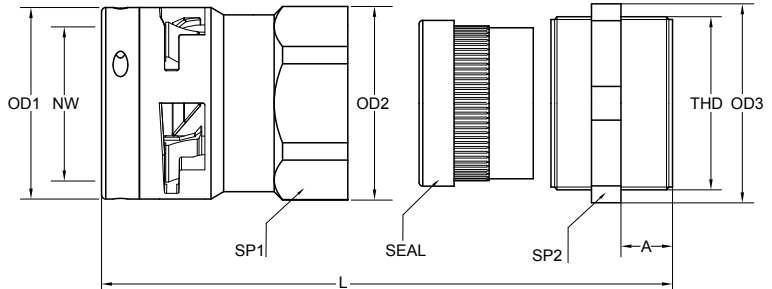
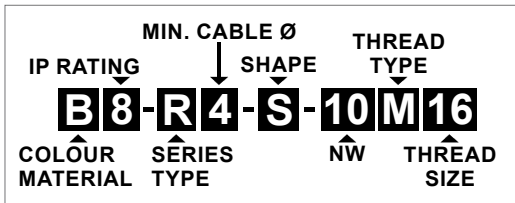

Specifications are subject to change without notice

METRIC METAL THREAD

Order No.	THD	Fits to Conduit			Cable Range	Seal Colour	A		L		OD1		OD2		OD3		SP1		SP2	
		Metric	NW	mm			in	mm	in	mm	in	mm	in	mm	in	mm	in	mm	in	mm
B8-R4-S-07M12	M12X1.5	7	10	1/4	4 - 6.5	Yellow	5.0	0.20	46.5	1.83	17.0	0.67	19.0	0.75	16.5	0.65	17.0	0.67	15.0	0.59
B8-R4-S-10M16	M16x1.5	10	12	5/16	4 - 6.5	Yellow	8.0	0.31	50.9	2.00	20.0	0.79	22.0	0.87	21.0	0.83	20.0	0.79	19.0	0.75
B8-R5-S-10M16					5 - 8	Grey														
B8-R6.5-S-10M16					6.5 - 9.5	Black														
B8-R7-S-12M16	M16x1.5	12	16	3/8	7 - 10.5	Green	6.0	0.24	53.2	2.09	24.0	0.94	27.0	1.06	22.0	0.87	24.0	0.94	20.0	0.79
B8-R6.5-S-12M20	M20x1.5	12	16	3/8	4 - 6.5	Yellow	8.0	0.31	55.2	2.17	24.0	0.94	27.0	1.06	24.0	0.94	24.0	0.94	22.0	0.87
B8-R5-S-12M20					5 - 8	Grey														
B8-R6-S-12M20					6.5 - 9.5	Black														
B8-R7-S-12M20					7 - 10.5	Green														
B8-R4-S-17M20	M20x1.5	17	20	1/2	4 - 6.5	Yellow	8.0	0.31	56.4	2.22	30.0	1.18	29.0	1.14	24.0	0.94	26.0	1.02	22.0	0.87
B8-R5-S-17M20					5 - 8	Grey														
B8-R6.5-S-17M20					6.5 - 9.5	Black														
B8-R7-S-17M20					7 - 10.5	Green														
B8-R9-S-17M20					9 - 13	Red														
B8-R4-S-17M25	M25x1.5	17	20	1/2	4 - 6.5	Yellow	9.0	0.35	57.4	2.26	30.0	1.18	30.0	1.18	30.0	1.18	27.0	1.06	28.0	1.10
B8-R5-S-17M25					5 - 8	Grey														
B8-R6.5-S-17M25					6.5 - 9.5	Black														
B8-R7-S-17M25					7 - 10.5	Green														
B8-R9-S-17M25					9 - 13	Red														
B8-R11.5-S-17M25					11.5 - 15.5	White														
B8-R9-S-23M25	M25x1.5	23	25	3/4	9 - 13	Red	9.0	0.35	70.5	2.78	38.0	1.50	38.0	1.50	33.0	1.30	34.0	1.34	30.0	1.18
B8-R11.5-S-23M25					11.5 - 15.5	White														
B8-R14-S-23M25					14 - 18	Blue														
B8-R17-S-23M25					17 - 20.5	Brown														
B8-R7-S-23M32	M32x1.5	23	25	3/4	7 - 10.5	Green	10.0	0.39	71.5	2.81	38.0	1.50	38.0	1.50	37.5	1.48	34.0	1.34	35.0	1.38
B8-R9-S-23M32					9 - 13	Red														
B8-R11.5-S-23M32					11.5 - 15.5	White														
B8-R14-S-23M32					14 - 18	Blue														
B8-R17-S-23M32					17 - 20.5	Brown														
B8-R20-S-29M32	M32x1.5	29	32	1	20 - 25	Orange	10.0	0.39	74.5	2.93	45.5	1.79	46.0	1.81	43.0	1.69	42.0	1.65	40.0	1.57
B8-R27-S-36M40	M40x1.5	36	40	1-1/4	27 - 32	Anthracite	8.5	0.33	81.5	3.21	57.0	2.24	61.0	2.40	55.0	2.17	55.0	2.17	50.0	1.97
B8-R29-S-36M40					29 - 34	Light blue														
B8-R27-S-36M50					27 - 32	Anthracite														
B8-R29-S-36M50	M50x1.5	36	40	1-1/4	29 - 34	Light blue	12.0	0.47	85.0	3.35	57.0	2.24	61.0	2.40	57.0	2.24	55.0	2.17	52.0	2.05
B8-R32-S-36M50					32 - 36	Pink														
B8-R39-S-48M63					M63x1.5	48														



NPT METAL THREAD

Order No.	THD	Fits to Conduit			Cable Range	Seal Colour	A		L		OD1		OD2		OD3		SP1		SP2	
		IP68	NPT	NW			mm	in	mm	in	mm	in	mm	in	mm	in	mm	in	mm	in
L8-R4-S-12N01	3/8	12	16	3/8	4 - 6.5	Yellow	13.0	0.51	61.0	2.40	24.0	0.94	27.0	1.06	28.0	1.10	24.0	0.94	25.4	1.00
L8-R5-S-12N01					5 - 8	Grey														
L8-R6.5-S-12N01					6.5 - 9.5	Black														
L8-R7-S-12N01					7 - 10.5	Green														
L8-R4-S-17N02	1/2	17	20	1/2	4 - 6.5	Yellow	13.5	0.53	66.0	2.60	30.0	1.18	30.0	1.18	28.0	1.10	27.0	1.06	25.4	1.00
L8-R5-S-17N02					5 - 8	Grey														
L8-R6.5-S-17N02					6.5 - 9.5	Black														
L8-R7-S-17N02					7 - 10.5	Green														
L8-R9-S-17N02					9 - 13	Red														
L8-R11.5-S-17N02					11.5 - 15.5	White														
L8-R7-S-23N04	3/4	23	25	3/4	7 - 10.5	Green	15.0	0.59	78.0	3.07	38.0	1.50	38.0	1.50	34.0	1.34	34.0	1.34	31.8	1.25
L8-R9-S-23N04					9 - 13	Red														
L8-R11.5-S-23N04					11.5 - 15.5	White														
L8-R14-S-23N04					14 - 18	Blue														
L8-R17-S-23N04	17 - 20.5	Brown																		
L8-R11.5-S-29N06	1	29	32	1	11.5 - 15.5	White	20.0	0.79	86.0	3.39	45.5	1.79	46.0	1.81	48.0	1.89	42.0	1.65	44.5	1.75
L8-R14-S-29N06					14 - 18	Blue														
L8-R17-S-29N06					17 - 20.5	Brown														
L8-R20-S-29N06					20 - 25	Orange														
L8-R24-S-29N06					24 - 28	Light Yellow														
L8-R27-S-36N07	1-1/4	36	40	1-1/4	27 - 32	Anthracite	20.0	0.79	86.0	3.39	57.0	2.24	61.0	2.40	55.0	2.17	55.0	2.17	50.8	2.00
L8-R29-S-36N07					29 - 34	Light Blue														
L8-R32-S-36N07					32 - 36	Pink														
L8-R39-S-48N09	1-1/2	48	50	1-1/2	39 - 44	White	20.0	0.79	106.0	4.17	68.0	2.68	76.0	2.99	70.0	2.76	70.0	2.76	63.5	2.50

PG METAL THREAD

Order No.	THD	Fits to Conduit			Cable Range	Seal Colour	A		L		OD1		OD2		OD3		SP1		SP2	
		IP68	PG	NW			mm	in	mm	in	mm	in	mm	in	mm	in	mm	in	mm	in
B8-R4-S-07P07	7	7	10	1/4	4 - 6.5	Yellow	5.0	0.20	46.5	1.83	17.0	0.67	19.0	0.75	16.5	0.65	17.0	0.67	15.0	0.59
B8-R4-S-10P09	9	10	12	5/16	4 - 6.5	Yellow	6.0	0.24	49.4	1.94	20.0	0.79	22.0	0.87	19.0	0.75	20.0	0.79	17.0	0.67
B8-R5-S-10P09					5 - 8	Grey														
B8-R6.5-S-10P09					6.5 - 9.5	Black														
B8-R4-S-12P11	11	12	16	3/8	4 - 6.5	Yellow	6.0	0.24	53.2	2.09	24.0	0.94	27.0	1.06	22.0	0.87	24.0	0.94	20.0	0.79
B8-R5-S-12P11					5 - 8	Grey														
B8-R6.5-S-12P11					6.5 - 9.5	Black														
B8-R7-S-12P11					7 - 10.5	Green														
B8-R4-S-17P13	13.5	17	20	1/2	4 - 6.5	Yellow	6.5	0.26	54.9	2.16	30.0	1.18	29.0	1.14	24.0	0.94	26.0	1.02	22.0	0.87
B8-R5-S-17P13					5 - 8	Grey														
B8-R6.5-S-17P13					6.5 - 9.5	Black														
B8-R7-S-17P13					7 - 10.5	Green														
B8-R9-S-17P13					9 - 13	Red														
B8-R4-S-17P16	16	17	20	1/2	4 - 6.5	Yellow	6.5	0.26	54.9	2.16	30.0	1.18	30.0	1.18	26.5	1.04	27.0	1.06	24.0	0.94
B8-R5-S-17P16					5 - 8	Grey														
B8-R6.5-S-17P16					6.5 - 9.5	Black														
B8-R7-S-17P16					7 - 10.5	Green														
B8-R9-S-17P16					9 - 13	Red														
B8-R11.5-S-17P16					11.5 - 15.5	White														
B8-R7-S-23P21	21	23	25	3/4	7 - 10.5	Green	7.5	0.30	69.0	2.72	38.0	1.50	38.0	1.50	32.0	1.26	34.0	1.34	30.0	1.18
B8-R9-S-23P21					9 - 13	Red														
B8-R11.5-S-23P21					11.5 - 15.5	White														
B8-R14-S-23P21					14 - 18	Blue														
B8-R17-S-23P21	17 - 20.5	Brown																		
B8-R11.5-S-29P29	29	29	32	1	11.5 - 15.5	White	9.3	0.36	73.3	2.88	45.5	1.79	46.0	1.81	43.0	1.69	42.0	1.65	40.0	1.57
B8-R14-S-29P29					14 - 18	Blue														
B8-R17-S-29P29					17 - 20.5	Brown														
B8-R20-S-29P29					20 - 25	Orange														
B8-R24-S-29P29					24 - 28	Light yellow														
B8-R27-S-36P36	36	36	40	1-1/4	27 - 32	Anthracite	9.0	0.35	82.0	3.23	57.0	2.24	61.0	2.40	55.0	2.17	55.0	2.17	50.0	1.97
B8-R29-S-36P36					29 - 34	Light blue														
B8-R32-S-36P36					32 - 36	Pink														
B8-R39-S-48P48	48	48	50	1-1/2	39 - 44	White	10.0	0.39	93.5	3.68	68.0	2.68	76.0	2.99	70.0	2.76	70.0	2.76	64.0	2.52

TEARLEX



ACCORDING TO MIL-DTL-5015/VG-95234 CIRCULAR CONNECTORS

- Locking device system provides a quick and secure push-in connection of corrugated conduits
- High-grade formulated polyamide
- Self-extinguishing, free from halogens and cadmium
- Temperature range: -40°C(-40°F) to 105°C(221°F), Short-term to 160°C(320°F)
- Up to IP68 / NEMA 6P protection at conduit side
- Colour: Black standard, other colours available upon request

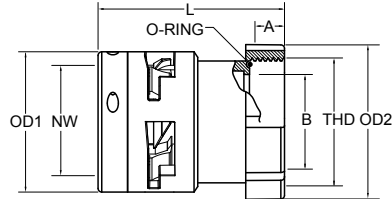
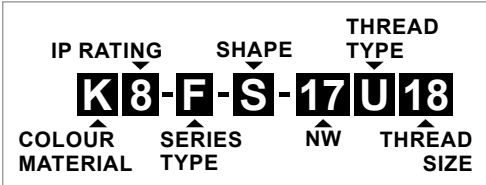

Specifications are subject to change without notice

UNE F
TH READ

Order No.	THD	Shell Size	Fits to Conduit			A		B		L		OD1		OD2	
			MIL-C5015	NW	mm	in	mm	in	mm	in	mm	in	mm	in	
IP68															
K8-F-S-12U15	5/8"-24	10	12	16	3/8	8.0	0.31	9.6	0.38	40.7	1.60	24.0	0.94	21.0	0.83
K8-F-S-12U21	7/8"-20	16	12	16	3/8	9.0	0.35	14.7	0.58	41.7	1.64	24.0	0.94	27.0	1.06
K8-F-S-17U18	3/4"-20	14	17	20	1/2	9.0	0.35	12.5	0.49	42.9	1.69	30.0	1.18	26.0	1.02
K8-F-S-17U21	7/8"-20	16	17	20	1/2	9.0	0.35	15.5	0.61	42.9	1.69	30.0	1.18	27.0	1.06
K8-F-S-17U24	1"-20	18	17	20	1/2	9.0	0.35	17.5	0.69	42.9	1.69	30.0	1.18	30.0	1.18
K8-F-S-17U29	1" 3/16-18	20 / 22	17	20	1/2	9.0	0.35	20.0	0.79	42.9	1.69	30.0	1.18	35.0	1.38
K8-F-S-23U29	1" 3/16-18	20 / 22	23	25	3/4	9.0	0.35	23.0	0.91	52.0	2.05	38.0	1.50	36.0	1.42
K8-F-S-23U35	1" 7/16-18	24 / 28	23	25	3/4	10.0	0.39	26.0	1.02	53.0	2.09	38.0	1.50	42.0	1.65
K8-F-S-29U35	1" 7/16-18	24 / 28	29	32	1	10.0	0.39	29.5	1.16	54.5	2.15	45.5	1.79	42.0	1.65
K8-F-S-29U43	1" 3/4-18 UNS	32	29	32	1	10.0	0.39	32.5	1.28	54.0	2.13	45.5	1.79	50.0	1.97
K8-F-S-36U35	1" 7/16-18	24	36	40	1-1/4	10.0	0.39	29.5	1.16	62.5	2.46	57.0	2.24	50.0	1.97
K8-F-S-36U43	1" 3/4-18 UNS	32	36	40	1-1/4	10.0	0.39	36.5	1.44	62.5	2.46	57.0	2.24	50.0	1.97
K8-F-S-36U50	2"-18 UNS	36	36	40	1-1/4	10.5	0.41	41.0	1.61	63.0	2.48	57.0	2.24	56.0	2.20
K8-F-S-48U56	2" 1/4-16 UN	40	48	50	1-1/2	10.5	0.41	48.5	1.91	70.0	2.76	68.0	2.68	63.0	2.48

KFAS Straight Female Thread, Polyamide Connector for AMP series

TEARLEX



- Locking device system provides a quick and secure push-in connection of corrugated conduits
- High-grade formulated polyamide
- Self-extinguishing, free from halogens and cadmium
- Temperature range: -40°C(-40°F) to 105°C(221°F), Short-term to 160°C(320°F)
- Up to IP66 / NEMA 4X protection at conduit side
- Colour: Black standard, other colours available upon request

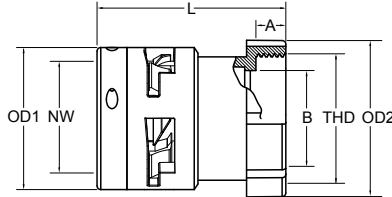
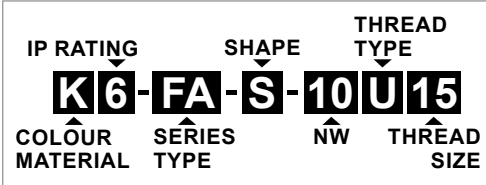

Specifications are subject to change without notice

UNE F
TH READ

Order No.	THD	Fits to Conduit	A		B		L		OD1		OD2			
			NW	mm	in	mm	in	mm	in	mm	in			
IP66														
K6-FA-S-07U15	5/8-24 UNEF	7	10	1/4	8.0	0.31	9.0	0.35	35.5	1.40	17.0	0.67	21.0	0.83
K6-FA-S-10U15	5/8-24 UNEF	10	12	5/16	8.0	0.31	10.5	0.41	36.4	1.43	20.0	0.79	21.0	0.83
K6-FA-S-10U18	3/4-20 UNEF	10	12	5/16	8.0	0.31	11.0	0.43	36.4	1.43	20.0	0.79	26.0	1.02
K6-FA-S-12U15	5/8-24 UNEF	12	16	3/8	8.0	0.31	12.0	0.47	40.2	1.58	24.0	0.94	21.0	0.83
K6-FA-S-12U18	3/4-20 UNEF	12	16	3/8	8.0	0.31	14.7	0.58	41.2	1.62	24.0	0.94	26.0	1.02
K6-FA-S-12U23	15/16-20 UNEF	12	16	3/8	8.0	0.31	12.0	0.47	41.2	1.62	24.0	0.94	30.0	1.18
K6-FA-S-17U18	3/4-20 UNEF	17	20	1/2	8.0	0.31	16.0	0.63	39.9	1.57	30.0	1.18	26.0	1.02
K6-FA-S-17U23	15/16-20 UNEF	17	20	1/2	8.0	0.31	16.0	0.63	40.9	1.61	30.0	1.18	30.0	1.18
K6-FA-S-17U34	1-3/8-18 UNEF	17	20	1/2	8.0	0.31	16.0	0.63	42.4	1.67	30.0	1.18	42.0	1.65
K6-FA-S-17U40	1-5/8-18 UNEF	17	20	1/2	8.0	0.31	16.0	0.63	59.9	2.36	30.0	1.18	48.0	1.89
K6-FA-S-23U23	15/16-20 UNEF	23	25	3/4	8.0	0.31	22.0	0.87	51.5	2.03	38.0	1.50	38.0	1.18
K6-FA-S-23U34	1-3/8-18 UNEF	23	25	3/4	8.0	0.31	22.0	0.87	50.5	1.99	38.0	1.50	42.0	1.65



- Locking device system provides a quick and secure push-in connection of corrugated conduits
- High-grade formulated polyamide
- Self-extinguishing, free from halogens and cadmium
- Temperature range: -40°C(-40°F) to 105°C(221°F), Short-term to 160°C(320°F)
- Up to IP66 / NEMA 4X protection at conduit side
- Colour: Black standard, other colours available upon request

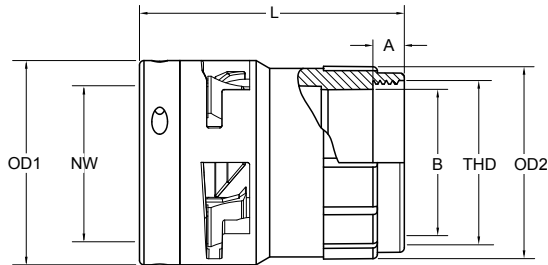

IP RATING SHAPE THREAD TYPE
K6-FB-S-12U20
 COLOUR MATERIAL SERIES TYPE NW THREAD SIZE

Specifications are subject to change without notice

Order No.	THD	Fits to Conduit			A		B		L		OD1		OD2	
		IP66	UNEF	NW	mm	in	mm	in	mm	in	mm	in	mm	in
K6-FB-S-12U20	13/16-20 UNEF	12	16	3/8	5.0	0.20	17.5	0.69	47.7	1.88	24.0	0.94	26.0	1.02
K6-FB-S-12U23	15/16-20 UNEF	12	16	3/8	5.0	0.20	20.5	0.81	50.7	1.99	24.0	0.94	30.0	1.18
K6-FB-S-17U23	15/16-20 UNEF	17	20	1/2	5.0	0.20	21.9	0.86	46.9	1.84	30.0	1.18	30.0	1.18
K6-FB-S-17U29	1-3/16-18 UNEF	17	20	1/2	7.0	0.28	26.0	1.02	47.4	1.86	30.0	1.18	36.0	1.42
K6-FB-S-23U29	1-3/16-18 UNEF	23	25	3/4	7.0	0.28	26.0	1.02	56.0	2.20	38.0	1.50	36.0	1.42
K6-FB-S-23U35	1-7/16-18 UNEF	23	25	3/4	7.0	0.28	32.5	1.28	58.0	2.28	38.0	1.50	43.0	1.69
K6-FB-S-29U35	1-7/16-18 UNEF	29	32	1	7.0	0.28	32.5	1.28	59.0	2.32	45.5	1.79	43.0	1.69

UNEF THREAD

CFS Straight Female Thread Connector for Electronic Sensors



- Locking device system provides a quick and secure push-in connection of corrugated conduits
- High-grade formulated polyamide
- Self-extinguishing, free from halogens and cadmium
- Temperature range: -40°C(-40°F) to 105°C(221°F), Short-term to 160°C(320°F)
- Up to IP66 / NEMA 4X protection at conduit side
- Clear body allows for visibility of electronic sensors

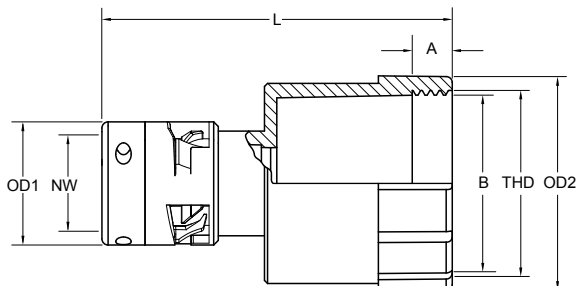

IP RATING SHAPE THREAD TYPE
C6-F-S-10F12
 COLOUR MATERIAL SERIES TYPE NW THREAD SIZE

Specifications are subject to change without notice

Order No.	THD	Fits to Conduit			B		A		L		OD1		OD2	
		IP66	Metric	NW	mm	in	mm	in	mm	in	mm	in	mm	in
C6-F-S-07F08	M08x1.0	7	10	1/4	7.0	0.28	8.0	0.31	34.0	1.34	17.0	0.67	14.0	0.55
C6-F-S-07F12	M12x1.0	7	10	1/4	11.0	0.43	6.5	0.26	52.0	2.05	17.0	0.67	17.0	0.67
C6-F-S-07F18	M18x1.0	7	10	1/4	17.0	0.67	6.5	0.26	59.0	2.32	17.0	0.67	23.0	0.91
C6-F-S-07F30	M30X1.5	7	10	1/4	28.5	1.12	6.5	0.26	55.5	2.38	17.0	0.67	35.0	1.38
C6-F-S-10F12	M12x1.0	10	12	5/16	11.0	0.43	6.5	0.26	53.4	2.10	20.0	0.79	17.0	0.67
C6-F-S-10F18	M18x1.0	10	12	5/16	17.0	0.67	6.5	0.26	60.4	2.38	20.0	0.79	23.0	0.91
C6-F-S-10F30	M30X1.5	10	12	5/16	28.5	1.12	6.5	0.26	56.9	2.24	20.0	0.79	35.0	1.38

METRIC THREAD

TEARLEX



- Locking device system provides a quick and secure push-in connection of corrugated conduits
- High-grade formulated polyamide
- Self-extinguishing, free from halogens and cadmium
- Temperature range: -40°C(-40°F) to 105°C(221°F), Short-term to 160°C(320°F)
- Up to IP68 / NEMA 6P protection at conduit side
- Colour: Black standard, other colours available upon request

IP RATING: **K8-F-S-17P16**
 SHAPE: **K8-F-S-17P16**
 THREAD TYPE: **K8-F-S-17P16**
 COLOUR MATERIAL: **K8-F-S-17P16**
 SERIES TYPE: **K8-F-S-17P16**
 NW: **K8-F-S-17P16**
 THREAD SIZE: **K8-F-S-17P16**

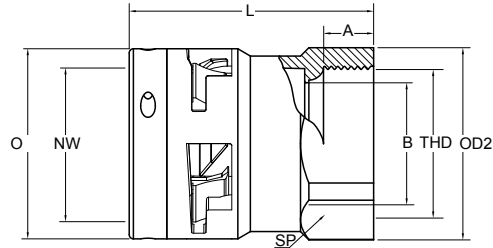

Specifications are subject to change without notice

PG THREAD

Order No.	THD	Fits to Conduit		A		B		L		OD1		OD2		SP		
		PG	NW	mm	in	mm	in	mm	in	mm	in	mm	in	mm	in	
K8-F-S-07P07	7	7	10	1/4	9.0	0.35	7.1	0.28	37.5	1.48	17.0	0.67	19.0	0.75	17.0	0.67
K8-F-S-10P07	7	10	12	5/16	9.0	0.35	7.1	0.28	38.9	1.53	20.0	0.79	19.0	0.75	17.0	0.67
K8-F-S-10P09	9	10	12	5/16	9.0	0.35	10.1	0.40	39.4	1.55	20.0	0.79	22.0	0.87	20.0	0.79
K8-F-S-12P11	11	12	16	3/8	9.6	0.38	11.5	0.45	43.3	1.70	24.0	1.18	27.0	1.06	24.0	0.94
K8-F-S-12P13	13.5	12	16	3/8	9.5	0.37	13.5	0.53	43.2	1.70	24.0	0.94	29.0	1.14	26.0	1.02
K8-F-S-17P13	13.5	17	20	1/2	9.5	0.37	13.5	0.53	44.4	1.75	30.0	1.18	29.0	1.14	26.0	1.02
K8-F-S-17P16	16	17	20	1/2	9.0	0.35	16.2	0.64	43.4	1.71	30.0	1.18	30.0	1.18	27.0	1.06
K8-F-S-23P21	21	23	25	3/4	11.0	0.43	21.0	0.83	57.0	2.24	38.0	1.50	38.0	1.50	34.0	1.34
K8-F-S-23P29	29	23	25	3/4	13.0	0.51	26.0	1.02	59.5	2.34	38.0	1.50	46.0	1.81	42.0	1.65
K8-F-S-29P29	29	29	32	1	13.0	0.51	29.2	1.15	59.5	2.34	45.5	1.79	46.0	1.81	42.0	1.65
K8-F-S-36P36	36	36	40	1-1/4	13.5	0.53	37.8	1.49	68.0	2.68	57.0	2.24	61.0	2.40	55.0	2.17
K8-F-S-48P48	48	48	50	1-1/2	15.0	0.59	47.0	1.85	76.5	3.01	68.0	2.68	76.0	2.99	70.0	2.76

BFS

Straight, Female Metal Thread, Polyamide Connector

TEARLEX



- Locking device system provides a quick and secure push-in connection of corrugated conduits
- High-grade formulated polyamide, with internal electroless nickel plated brass thread
- Self-extinguishing, free from halogens and cadmium
- Temperature range: -40°C(-40°F) to 105°C(221°F), Short-term to 160°C(320°F)
- Up to IP68 / NEMA 6P protection at conduit side
- Colour: Black standard, other colours available upon request

IP RATING: **B8-F-S-17P16**
 SHAPE: **B8-F-S-17P16**
 THREAD TYPE: **B8-F-S-17P16**
 COLOUR MATERIAL: **B8-F-S-17P16**
 SERIES TYPE: **B8-F-S-17P16**
 NW: **B8-F-S-17P16**
 THREAD SIZE: **B8-F-S-17P16**

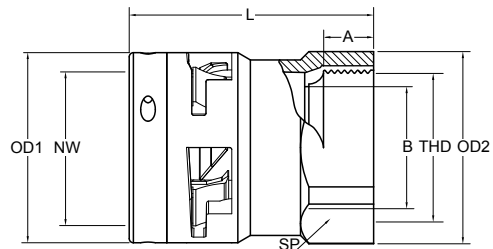

PG METAL THREAD

Order No.	THD	Fits to Conduit		A		B		L		OD1		OD2		SP		
		PG	NW	mm	in	mm	in	mm	in	mm	in	mm	in	mm	in	
B8-F-S-07P07	7	7	10	1/4	8.0	0.31	7.1	0.28	36.5	1.44	17.0	0.67	19.0	0.75	17.0	0.67
B8-F-S-10P09	9	10	12	5/16	8.0	0.31	10.1	0.40	38.4	1.51	20.0	0.79	22.0	0.87	20.0	0.79
B8-F-S-12P11	11	12	16	3/8	8.5	0.33	11.5	0.45	42.2	1.66	24.0	0.94	27.0	1.06	24.0	0.94
B8-F-S-17P13	13.5	17	20	1/2	8.5	0.33	13.5	0.53	43.4	1.71	30.0	1.50	29.0	1.14	26.0	1.02
B8-F-S-17P16	16	17	20	1/2	9.0	0.35	16.2	0.64	43.4	1.71	30.0	1.18	30.0	1.18	27.0	1.06
B8-F-S-23P21	21	23	25	3/4	10.0	0.39	21.0	0.83	56.0	2.20	38.0	1.50	38.0	1.50	34.0	1.34
B8-F-S-29P29	29	29	32	1	12.0	0.47	29.0	1.14	58.5	2.30	45.5	1.79	46.0	1.81	42.0	1.65
B8-F-S-36P36	36	36	40	1-1/4	12.5	0.49	37.8	1.49	67.0	2.64	57.0	2.24	61.0	2.40	55.0	2.17
B8-F-S-48P48	48	48	50	1-1/2	15.0	0.59	47.0	1.85	76.5	3.01	68.0	2.68	76.0	2.99	70.0	2.76



- Locking device system provides a quick and secure push-in connection of corrugated conduits
- High-grade formulated polyamide, with black anodized aluminum thread
- Self-extinguishing, free from halogens and cadmium
- Excellent impact strength
- Temperature range: -40°C(-40°F) to 105°C(221°F)
- Short-term to 160°C(320°F)
- Up to IP68 / NEMA 6P protection with the reinforced sealing cap at conduit side
- Colour: Black standard, other colours available upon request

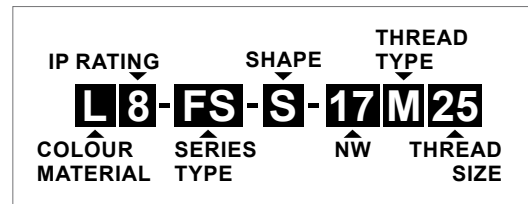
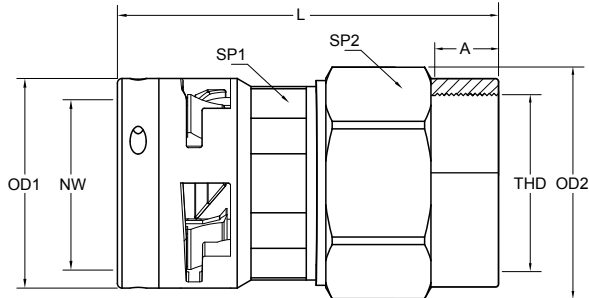

Specifications are subject to change without notice

Order No. IP66	Order No. IP68	THD Metric	Fits to Conduit			A		L		OD1		OD2		SP1		SP2	
			NW	mm	in	mm	in	mm	in	mm	in	mm	in	mm	in	mm	in
L6-FS-S-10M16	L8-FS-S-10M16	M16x1.5	10	12	5/16	11.0	0.43	54.5	2.10	20.0	0.79	28.0	1.10	17.0	0.67	25.4	1.00
L6-FS-S-12M16	L8-FS-S-12M16	M16x1.5	12	16	3/8	11.0	0.43	58.3	2.25	24.0	0.94	28.0	1.10	20.0	0.79	25.4	1.00
L6-FS-S-17M20	L8-FS-S-17M20	M20x1.5	17	20	1/2	12.0	0.47	60.6	2.34	30.0	1.18	35.0	1.38	26.0	1.02	31.8	1.25
L6-FS-S-17M25	L8-FS-S-17M25	M25x1.5	17	20	1/2	12.0	0.47	60.6	2.34	30.0	1.50	35.0	1.38	26.0	1.02	31.8	1.25
L6-FS-S-23M25	L8-FS-S-23M25	M25x1.5	23	25	3/4	12.0	0.47	69.5	2.70	38.0	1.50	42.0	1.65	32.0	1.26	38.1	1.50
L6-FS-S-23M32	L8-FS-S-23M32	M32x1.5	23	25	3/4	12.0	0.47	69.9	2.70	38.0	1.50	42.0	1.65	32.0	1.26	38.1	1.50
L6-FS-S-29M32	L8-FS-S-29M32	M32x1.5	29	32	1	13.5	0.53	74.5	2.83	45.5	1.79	49.0	1.93	40.0	1.57	44.5	1.75
L6-FS-S-36M40	L8-FS-S-36M40	M40x1.5	36	40	1-1/4	13.5	0.53	82.9	3.19	57.0	2.24	56.0	2.20	50.0	1.97	50.8	2.00
L6-FS-S-48M50	L8-FS-S-48M50	M50x1.5	48	50	1-1/2	14.5	0.57	93.4	3.62	68.0	2.68	70.0	2.76	64.0	2.52	63.5	2.50
L6-FS-S-48M63	L8-FS-S-48M63	M63x1.5	48	50	1-1/2	14.5	0.57	93.4	3.62	68.0	2.68	78.0	3.07	64.0	2.52	69.8	2.75

METRIC METAL THREAD

Order No. IP66	Order No. IP68	THD NPT	Fits to Conduit			A		L		OD1		OD2		SP1		SP2	
			NW	mm	in	mm	in	mm	in	mm	in	mm	in	mm	in	mm	in
L6-FS-S-12N02	L8-FS-S-12N02	1/2	12	16	3/8	11.0	0.43	59.2	2.33	24.0	0.94	28.0	1.10	20.0	0.79	25.4	1.00
L6-FS-S-17N02	L8-FS-S-17N02	1/2	17	20	1/2	13.5	0.53	62.1	2.44	30.0	1.79	35.0	1.38	26.0	1.02	31.8	1.25
L6-FS-S-23N04	L8-FS-S-23N04	3/4	23	25	3/4	14.0	0.55	71.9	2.83	38.0	1.50	42.0	1.65	32.0	1.26	38.1	1.50
L6-FS-S-29N06	L8-FS-S-29N06	1	29	32	1	17.3	0.68	78.5	3.09	45.5	1.79	49.0	1.93	40.0	1.57	44.5	1.75
L6-FS-S-36N07	L8-FS-S-36N07	1-1/4	36	40	1-1/4	18.0	0.71	87.4	3.44	57.0	2.24	56.0	2.20	50.0	1.97	50.8	2.00
L6-FS-S-48N09	L8-FS-S-48N09	2	48	50	1-1/2	19.0	0.75	97.9	3.85	68.0	2.68	70.0	2.76	64.0	2.52	63.5	2.50

NPT METAL THREAD

Order No. IP66	Order No. IP68	THD PG	Fits to Conduit			A		L		OD1		OD2		SP1		SP2	
			NW	mm	in	mm	in	mm	in	mm	in	mm	in	mm	in	mm	in
L6-FS-S-10P09	L8-FS-S-10P09	9	10	12	5/16	11.0	0.43	54.5	2.15	20.0	0.79	28.0	1.10	17.0	0.67	25.4	1.00
L6-FS-S-12P11	L8-FS-S-12P11	11	12	16	3/8	11.0	0.43	58.3	2.30	24.0	0.94	28.0	1.10	20.0	0.79	25.4	1.00
L6-FS-S-17P13	L8-FS-S-17P13	13.5	17	20	1/2	12.0	0.47	60.6	2.39	30.0	1.18	35.0	1.38	26.0	1.02	31.8	1.25
L6-FS-S-17P16	L8-FS-S-17P16	16	17	20	1/2	12.0	0.47	60.6	2.39	30.0	1.18	35.0	1.38	26.0	1.02	31.8	1.25
L6-FS-S-23P21	L8-FS-S-23P21	21	23	25	3/4	12.0	0.47	69.9	2.75	38.0	1.50	42.0	1.65	32.0	1.26	38.1	1.50
L6-FS-S-29P29	L8-FS-S-29P29	29	29	32	1	13.5	0.53	74.5	2.93	45.5	1.79	49.0	1.93	40.0	1.57	44.5	1.75
L6-FS-S-36P36	L8-FS-S-36P36	36	36	40	1-1/4	13.5	0.53	82.9	3.26	57.0	2.24	56.0	2.20	50.0	1.97	50.8	2.00
L6-FS-S-48P48	L8-FS-S-48P48	48	48	50	1-1/2	14.5	0.57	93.4	3.68	68.0	2.68	70.0	2.76	64.0	2.52	63.5	2.50

PG METAL THREAD

TEAFLEX



- Locking device system provides a quick and secure push-in connection of corrugated conduits
- High-grade formulated polyamide, with black anodized aluminum thread
- Self-extinguishing, free from halogens and cadmium
- Excellent impact strength
- Temperature range: -40°C(-40°F) to 105°C(221°F)
- Short-term to 160°C(320°F)
- Up to IP68 / NEMA 6P protection with the reinforced sealing cap at conduit side
- Colour: Black standard, other colours available upon request

IP RATING: **L8**
SHAPE: **FS**
THREAD TYPE: **E-23M25**
COLOUR MATERIAL: **L8**
SERIES TYPE: **FS**
NW: **23**
THREAD SIZE: **25**

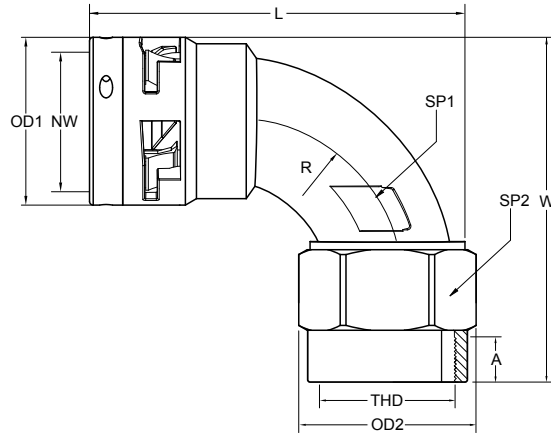

Specifications are subject to change without notice

METRIC METAL THREAD

Order No. IP66	Order No. IP68	THD Metric	Fits to Conduit			A		L		R		W		OD1		OD2		SP1		SP2	
			NW	mm	in	mm	in	mm	in	mm	in	mm	in	mm	in	mm	in	mm	in	mm	in
L6-FS-E-10M16	L8-FS-E-10M16	M16x1.5	10	12	5/16	11.0	0.43	60.5	2.38	31.2	1.23	58.5	2.30	20.0	0.79	28.0	1.10	17.0	0.67	25.4	1.00
L6-FS-E-12M16	L8-FS-E-12M16	M16x1.5	12	16	3/8	11.0	0.43	65.0	2.56	31.7	1.25	60.3	2.37	24.0	0.94	28.0	1.10	15.0	0.79	25.4	1.00
L6-FS-E-17M20	L8-FS-E-17M20	M20x1.5	17	20	1/2	12.0	0.47	76.0	2.99	36.6	1.44	70.6	2.78	30.0	1.18	35.0	1.38	20.0	1.02	31.8	1.25
L6-FS-E-17M25	L8-FS-E-17M25	M25x1.5	17	20	1/2	12.0	0.47	76.0	2.99	36.6	1.44	70.6	2.78	30.0	1.50	35.0	1.38	20.0	1.02	31.8	1.25
L6-FS-E-23M25	L8-FS-E-23M25	M25x1.5	23	25	3/4	12.0	0.47	90.0	3.54	41.5	1.63	80.0	3.15	38.0	1.50	42.0	1.65	26.0	1.26	38.1	1.50
L6-FS-E-23M32	L8-FS-E-23M32	M32x1.5	23	25	3/4	12.0	0.47	90.0	3.54	41.5	1.63	76.4	3.01	38.0	1.50	42.0	1.65	26.0	1.26	38.1	1.50
L6-FS-E-29M32	L8-FS-E-29M32	M32x1.5	29	32	1	13.5	0.53	101.8	4.01	47.5	1.87	89.0	3.50	45.5	1.79	49.0	1.93	32.0	1.57	44.5	1.75
L6-FS-E-36M40	L8-FS-E-36M40	M40x1.5	36	40	1-1/4	13.5	0.53	123.5	4.86	59.4	2.34	103.9	4.09	57.0	2.24	56.0	2.20	40.0	1.97	50.8	2.00
L6-FS-E-48M50	L8-FS-E-48M50	M50x1.5	48	50	1-1/2	14.5	0.57	142.5	5.61	63.3	2.49	116.4	4.58	68.0	2.68	70.0	2.76	55.0	2.52	63.5	2.50
L6-FS-E-48M63	L8-FS-E-48M63	M63x1.5	48	50	1-1/2	14.5	0.57	142.5	5.61	63.3	2.49	116.4	4.58	68.0	2.68	78.0	3.07	55.0	2.52	69.8	2.75

NPT METAL THREAD

Order No. IP66	Order No. IP68	THD NPT	Fits to Conduit			A		L		R		W		OD1		OD2		SP1		SP2	
			NW	mm	in	mm	in	mm	in	mm	in	mm	in	mm	in	mm	in	mm	in	mm	in
L6-FS-E-12N02	L8-FS-E-12N02	1/2	12	16	3/8	11.0	0.43	65.0	2.56	31.7	1.25	61.7	2.43	24.0	0.94	28.0	1.10	15.0	0.59	25.4	1.00
L6-FS-E-17N02	L8-FS-E-17N02	1/2	17	20	1/2	13.5	0.53	76.0	2.99	36.6	1.44	72.1	2.84	30.0	1.79	35.0	1.38	20.0	0.79	31.8	1.25
L6-FS-E-23N04	L8-FS-E-23N04	3/4	23	25	3/4	14.0	0.55	90.0	3.54	41.5	1.63	78.9	3.11	38.0	1.50	42.0	1.65	26.0	1.02	38.1	1.50
L6-FS-E-29N06	L8-FS-E-29N06	1	29	32	1	17.3	0.68	101.8	4.01	47.5	1.87	93.0	3.66	45.5	1.79	49.0	1.93	32.0	1.26	44.5	1.75
L6-FS-E-36N07	L8-FS-E-36N07	1-1/4	36	40	1-1/4	18.0	0.71	123.5	4.86	59.4	2.34	108.4	4.27	57.0	2.24	56.0	2.20	40.0	1.57	50.8	2.00
L6-FS-E-48N09	L8-FS-E-48N09	2	48	50	1-1/2	19.0	0.75	142.5	5.61	63.3	2.49	121.4	4.78	68.0	2.68	70.0	2.76	55.0	2.17	63.5	2.50

PG METAL THREAD

Order No. IP66	Order No. IP68	THD PG	Fits to Conduit			A		L		R		W		OD1		OD2		SP1		SP2	
			NW	mm	in	mm	in	mm	in	mm	in	mm	in	mm	in	mm	in	mm	in	mm	in
L6-FS-E-10P09	L8-FS-E-10P09	9	10	12	5/16	11.0	0.43	60.5	2.38	31.2	1.23	58.5	2.30	20.0	0.79	28.0	1.10	13.0	0.51	25.4	1.00
L6-FS-E-12P11	L8-FS-E-12P11	11	12	16	3/8	11.0	0.43	65.0	2.56	31.7	1.25	60.3	2.37	24.0	0.94	28.0	1.10	15.0	0.59	25.4	1.00
L6-FS-E-17P13	L8-FS-E-17P13	13.5	17	20	1/2	12.0	0.47	76.0	2.99	36.6	1.44	70.6	2.78	30.0	1.18	35.0	1.38	20.0	0.79	31.8	1.25
L6-FS-E-17P16	L8-FS-E-17P16	16	17	20	1/2	12.0	0.47	76.0	2.99	36.6	1.44	70.6	2.78	30.0	1.18	35.0	1.38	20.0	0.79	31.8	1.25
L6-FS-E-23P21	L8-FS-E-23P21	21	23	25	3/4	12.0	0.47	90.0	3.54	41.5	1.63	76.4	3.01	38.0	1.50	42.0	1.65	26.0	1.02	38.1	1.50
L6-FS-E-29P29	L8-FS-E-29P29	29	29	32	1	13.5	0.53	101.8	4.01	47.5	1.87	89.0	3.50	45.5	1.79	49.0	1.93	32.0	1.26	44.5	1.75
L6-FS-E-36P36	L8-FS-E-36P36	36	36	40	1-1/4	13.5	0.53	123.5	4.86	59.4	2.34	105.9	4.17	57.0	2.24	56.0	2.20	40.0	1.57	50.8	2.00
L6-FS-E-48P48	L8-FS-E-48P48	48	48	50	1-1/2	14.5	0.57	142.5	5.61	63.3	2.49	116.4	4.58	68.0	2.68	70.0	2.76	50.0	1.97	63.5	2.50



- Locking device system provides a quick and secure push-in connection of corrugated conduits
- High-grade formulated polyamide, with black anodized aluminum thread
- Self-extinguishing, free from halogens and cadmium
- Excellent impact strength
- Temperature range: -40°C(-40°F) to 105°C(221°F)
- Short-term to 160°C(320°F)
- Up to IP68 / NEMA 6P protection with the reinforced sealing cap at conduit side
- Colour: Black standard, other colours available upon request

TEAFLEX

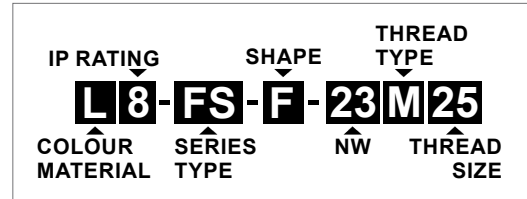
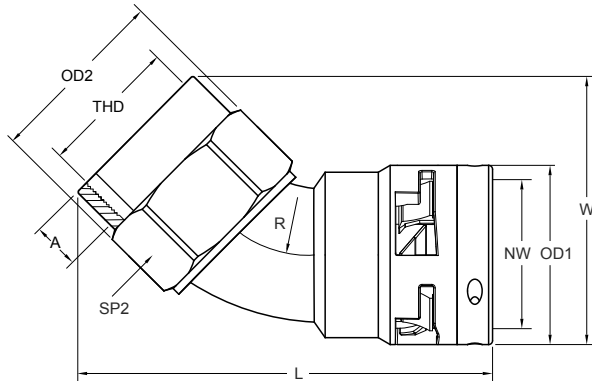

Specifications are subject to change without notice

Order No. IP66	Order No. IP68	THD Metric	Fits to Conduit			A		L		R		W		OD1		OD2		SP2	
			NW	mm	in	mm	in	mm	in	mm	in	mm	in	mm	in	mm	in	mm	in
L6-FS-F-10M16	L8-FS-F-10M16	M16x1.5	10	12	5/16	11.0	0.43	66.3	2.61	31.2	1.23	37.8	1.49	20.0	0.79	28.0	1.10	25.4	1.00
L6-FS-F-12M16	L8-FS-F-12M16	M16x1.5	12	16	3/8	11.0	0.43	69.7	2.74	31.6	1.24	41.5	1.63	24.0	0.94	28.0	1.10	25.4	1.00
L6-FS-F-17M20	L8-FS-F-17M20	M20x1.5	17	20	1/2	12.0	0.47	79.4	3.13	37.6	1.48	46.4	1.83	30.0	1.18	35.0	1.38	31.8	1.25
L6-FS-F-17M25	L8-FS-F-17M25	M25x1.5	17	20	1/2	12.0	0.47	81.2	3.20	37.6	1.48	48.2	1.90	30.0	1.18	35.0	1.38	31.8	1.25
L6-FS-F-23M25	L8-FS-F-23M25	M25x1.5	23	25	3/4	12.0	0.47	92.8	3.65	41.5	1.63	56.4	2.22	38.0	1.50	42.0	1.65	38.1	1.50
L6-FS-F-23M32	L8-FS-F-23M32	M32x1.5	23	25	3/4	12.0	0.47	93.3	3.67	41.5	1.63	56.9	2.24	38.0	1.50	42.0	1.65	38.1	1.50
L6-FS-F-29M32	L8-FS-F-29M32	M32x1.5	29	32	1	13.5	0.53	101.8	4.01	47.5	1.87	64.4	2.54	45.5	1.79	49.0	1.93	44.5	1.75
L6-FS-F-36M40	L8-FS-F-36M40	M40x1.5	36	40	1-1/4	13.5	0.53	115.9	4.56	59.4	2.34	74.3	2.93	57.0	2.24	56.0	2.20	50.8	2.00
L6-FS-F-48M50	L8-FS-F-48M50	M50x1.5	48	50	1-1/2	14.5	0.57	136.9	5.39	63.3	2.49	89.2	3.51	68.0	2.68	70.0	2.76	63.5	2.50
L6-FS-F-48M63	L8-FS-F-48M63	M63x1.5	48	50	1-1/2	14.5	0.57	140.2	5.52	63.3	2.49	92.4	3.64	68.0	2.68	78.0	3.07	69.8	2.75

METRIC METAL THREAD

Order No. IP66	Order No. IP68	THD NPT	Fits to Conduit			A		L		R		W		OD1		OD2		SP2	
			NW	mm	in	mm	in	mm	in	mm	in	mm	in	mm	in	mm	in	mm	in
L6-FS-F-12N02	L8-FS-F-12N02	1/2	12	16	3/8	11.0	0.43	71.8	2.83	31.6	1.24	44.0	1.73	24.0	0.94	28.0	1.10	25.4	1.00
L6-FS-F-17N02	L8-FS-F-17N02	1/2	17	20	1/2	13.5	0.53	82.4	3.24	37.6	1.48	50.5	1.99	30.0	1.18	28.0	1.10	25.4	1.00
L6-FS-F-23N04	L8-FS-F-23N04	3/4	23	25	3/4	14.0	0.55	92.8	3.65	41.5	1.63	57.5	2.26	38.0	1.50	35.0	1.38	31.8	1.25
L6-FS-F-29N06	L8-FS-F-29N06	1	29	32	1	17.3	0.68	105.3	4.15	47.5	1.87	67.5	2.66	45.5	1.79	49.0	1.93	44.5	1.75
L6-FS-F-36N07	L8-FS-F-36N07	1-1/4	36	40	1-1/4	18.0	0.71	119.7	4.71	59.4	2.34	71.5	2.81	57.0	2.24	56.0	2.20	50.8	2.00
L6-FS-F-48N09	L8-FS-F-48N09	2	48	50	1-1/2	19.0	0.75	140.1	5.52	63.3	2.49	96.5	3.80	68.0	2.68	70.0	2.76	63.5	2.50

NPT METAL THREAD

Order No. IP66	Order No. IP68	THD PG	Fits to Conduit			A		L		R		W		OD1		OD2		SP2	
			NW	mm	in	mm	in	mm	in	mm	in	mm	in	mm	in	mm	in	mm	in
L6-FS-F-10P09	L8-FS-F-10P09	9	10	12	5/16	11.0	0.43	59.0	2.32	31.2	1.23	35.0	1.38	20.0	0.79	21.0	0.83	19.1	0.75
L6-FS-F-12P11	L8-FS-F-12P11	11	12	16	3/8	11.0	0.43	70.5	2.78	31.6	1.24	45.0	1.77	24.0	0.94	28.0	1.10	25.4	1.00
L6-FS-F-17P13	L8-FS-F-17P13	13.5	17	20	1/2	12.0	0.47	77.5	3.05	37.6	1.48	48.0	1.89	30.0	1.18	35.0	1.38	31.8	1.25
L6-FS-F-17P16	L8-FS-F-17P16	16	17	20	1/2	12.0	0.47	78.0	3.07	37.6	1.48	49.0	1.93	30.0	1.18	35.0	1.38	31.8	1.25
L6-FS-F-23P21	L8-FS-F-23P21	21	23	25	3/4	12.0	0.47	91.5	3.60	41.5	1.63	55.0	2.17	38.0	1.50	42.0	1.65	38.1	1.50
L6-FS-F-29P29	L8-FS-F-29P29	29	29	32	1	13.5	0.53	103.0	4.06	47.5	1.87	65.5	2.58	45.5	1.79	49.0	1.93	44.5	1.75
L6-FS-F-36P36	L8-FS-F-36P36	36	36	40	1-1/4	13.5	0.53	119.0	4.69	59.4	2.34	78.5	3.09	57.0	2.24	56.0	2.20	50.8	2.00
L6-FS-F-48P48	L8-FS-F-48P48	48	48	50	1-1/2	14.5	0.57	140.5	5.53	63.3	2.49	93.5	3.68	68.0	2.68	70.0	2.76	63.5	2.50

PG METAL THREAD

TEAFLEX



- Locking device system provides a quick and secure push-in connection of corrugated conduits
- High-grade formulated polyamide, with black anodized aluminum thread
- Self-extinguishing, free from halogens and cadmium
- Excellent impact strength
- Temperature range: -40°C(-40°F) to 105°C(221°F)
- Short-term to 160°C(320°F)
- Up to IP68 / NEMA 6P protection with the reinforced sealing cap at conduit side
- Colour: Black standard, other colours available upon request

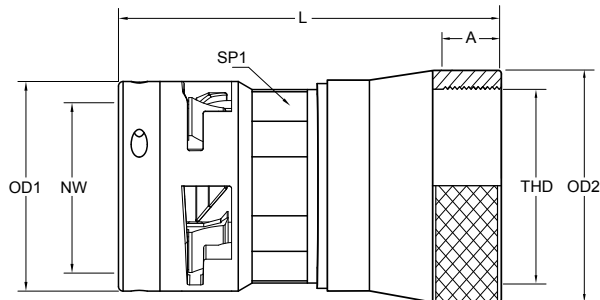
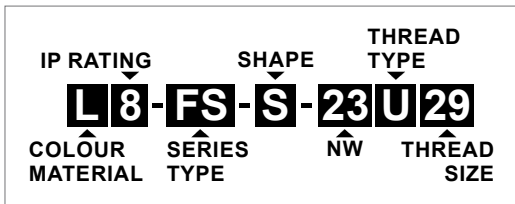

Specifications are subject to change without notice

UNEF METAL THREAD

Order No. IP66	Order No. IP68	THD UNEF	Fits to Conduit			A		L		OD1		SP1		OD2	
			NW	mm	in	mm	in	mm	in	mm	in	mm	in		
L6-FS-S-10U15	L8-FS-S-10U15	5/8"-24	10	12	5/16	8.0	0.31	52.0	2.05	20.0	0.79	17.0	0.67	23.5	0.93
L6-FS-S-12U13	L8-FS-S-12U13	9/16"-24	12	16	3/8	8.5	0.33	55.8	2.19	24.0	0.94	20.0	0.79	25.4	1.00
L6-FS-S-12U15	L8-FS-S-12U15	5/8"-24	12	16	3/8	8.0	0.31	55.3	2.18	24.0	0.94	20.0	0.79	25.4	1.00
L6-FS-S-17U18	L8-FS-S-17U18	3/4"-20	17	20	1/2	9.0	0.35	57.6	2.27	30.0	1.18	26.0	1.02	30.0	1.18
L6-FS-S-10U21	L8-FS-S-10U21	7/8"-20	10	12	5/16	9.0	0.35	52.5	2.07	20.0	0.79	17.0	0.67	27.0	1.06
L6-FS-S-12U21	L8-FS-S-12U21	7/8"-20	12	16	3/8	9.0	0.35	56.3	2.22	24.0	0.94	20.0	0.79	27.0	1.06
L6-FS-S-17U21	L8-FS-S-17U21	7/8"-20	17	20	1/2	9.0	0.35	57.6	2.27	30.0	1.18	26.0	1.02	30.0	1.18
L6-FS-S-12U24	L8-FS-S-12U24	1"-20	12	16	3/8	9.0	0.35	56.3	2.22	24.0	0.94	20.0	0.79	29.4	1.16
L6-FS-S-17U24	L8-FS-S-17U24	1"-20	17	20	1/2	9.0	0.35	57.6	2.27	30.0	1.18	26.0	1.02	30.0	1.18
L6-FS-S-23U24	L8-FS-S-23U24	1"-20	23	25	3/4	9.0	0.35	66.9	2.63	38.0	1.50	32.0	1.26	36.0	1.42
L6-FS-S-12U29	L8-FS-S-12U29	1 3/16"-18	12	16	3/8	9.0	0.35	58.3	2.30	24.0	0.94	20.0	0.79	34.2	1.35
L6-FS-S-17U29	L8-FS-S-17U29	1 3/16"-18	17	20	1/2	9.0	0.35	57.6	2.27	30.0	1.18	26.0	1.02	34.2	1.35
L6-FS-S-23U29	L8-FS-S-23U29	1 3/16"-18	23	25	3/4	9.0	0.35	66.9	2.63	38.0	1.50	32.0	1.26	36.0	1.42
L6-FS-S-29U29	L8-FS-S-29U29	1 3/16"-18	29	32	1	9.0	0.35	74.0	2.91	45.5	1.79	40.0	1.57	44.4	1.75
L6-FS-S-12U35	L8-FS-S-12U35	1 7/16"-18	12	16	3/8	9.0	0.35	65.0	2.56	24.0	0.94	20.0	0.79	40.5	1.59
L6-FS-S-17U35	L8-FS-S-17U35	1 7/16"-18	17	20	1/2	9.0	0.35	61.6	2.43	30.0	1.18	26.0	1.02	40.5	1.59
L6-FS-S-23U35	L8-FS-S-23U35	1 7/16"-18	23	25	3/4	9.0	0.35	66.9	2.63	38.0	1.50	32.0	1.26	40.5	1.59
L6-FS-S-29U35	L8-FS-S-29U35	1 7/16"-18	29	32	1	9.0	0.35	70.0	2.76	45.5	1.79	40.0	1.57	44.4	1.75
L6-FS-S-36U35	L8-FS-S-36U35	1 7/16"-18	36	40	1-1/4	9.0	0.35	78.4	3.09	57.0	2.24	50.0	1.97	50.8	2.00
L6-FS-S-17U43	L8-FS-S-17U43	1 3/4"-18UNS	17	20	1/2	10.0	0.39	61.6	2.43	30.0	1.18	26.0	1.02	48.5	1.91
L6-FS-S-23U43	L8-FS-S-23U43	1 3/4"-18UNS	23	25	3/4	10.0	0.39	73.0	2.87	38.0	1.50	32.0	1.26	48.5	1.91
L6-FS-S-29U43	L8-FS-S-29U43	1 3/4"-18UNS	29	32	1	10.0	0.39	71.0	2.80	45.5	1.79	40.0	1.57	50.5	1.99
L6-FS-S-36U43	L8-FS-S-36U43	1 3/4"-18UNS	36	40	1-1/4	10.0	0.39	79.4	3.13	57.0	2.24	50.0	1.97	50.8	2.00
L6-FS-S-23U50	L8-FS-S-23U50	2"-18UNS	23	25	3/4	10.0	0.39	73.0	2.87	38.0	1.50	32.0	1.26	54.8	2.16
L6-FS-S-29U50	L8-FS-S-29U50	2"-18UNS	29	32	1	10.0	0.39	71.0	2.80	45.5	1.79	40.0	1.57	56.8	2.24
L6-FS-S-36U50	L8-FS-S-36U50	2"-18UNS	36	40	1-1/4	10.0	0.39	79.4	3.13	57.0	2.24	50.0	1.97	56.8	2.24
L6-FS-S-48U50	L8-FS-S-48U50	2"-18UNS	48	50	1-1/2	10.0	0.39	88.9	3.50	68.0	2.68	64.0	2.52	66.0	2.60
L6-FS-S-23U56	L8-FS-S-23U56	2 1/4"-16UN	23	25	3/4	10.0	0.39	74.9	2.95	38.0	1.50	32.0	1.26	61.2	2.41
L6-FS-S-29U56	L8-FS-S-29U56	2 1/4"-16UN	29	32	1	10.0	0.39	74.0	2.91	45.5	1.79	40.0	1.57	63.5	2.50
L6-FS-S-36U56	L8-FS-S-36U56	2 1/4"-16UN	36	40	1-1/4	10.0	0.39	83.4	3.28	57.0	2.24	50.0	1.97	63.5	2.50
L6-FS-S-48U56	L8-FS-S-48U56	2 1/4"-16UN	48	50	1-1/2	10.0	0.39	88.9	3.50	68.0	2.68	64.0	2.52	66.0	2.60



ACCORDING TO
MIL-DTL-5015/VG-95234
CIRCULAR CONNECTORS

- Designed to thread directly onto circular connectors & houses environmental seal
- Locking device system provides a quick and secure push-in connection of corrugated conduits
- High-grade formulated polyamide, with black anodized aluminum thread
- Self-extinguishing, free from halogens and cadmium
- Excellent impact strength
- Temperature range: -40°C(-40°F) to 105°C(221°F)
- Short-term to 160°C(320°F)
- Up to IP68 / NEMA 6P protection with the reinforced sealing cap at conduit side
- Colour: Black standard, other colours available upon request

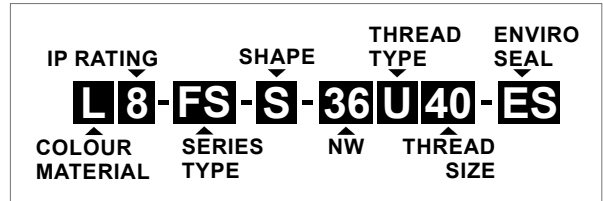
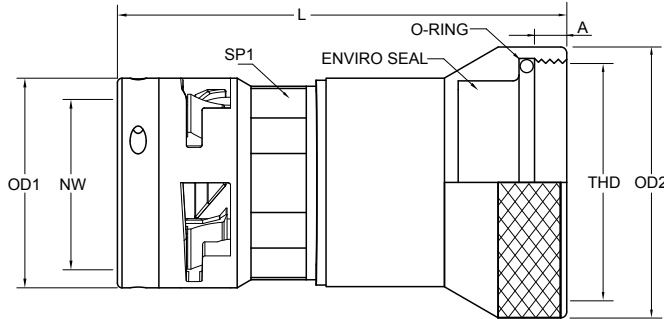

Specifications are subject to change without notice

Order No. IP66	Order No. IP68	THD UNEF	Shell Size MIL-C5015	Fits to Conduit			A		L		OD1		SP1		OD2	
				NW	mm	in	mm	in	mm	in	mm	in	mm	in	mm	in
L6-FS-S-10U15-ES	L8-FS-S-10U15-ES	5/8"-24	10SL	10	12	5/16	9.0	0.31	65.0	2.56	20.0	0.79	17.0	0.67	25.4	1.00
L6-FS-S-12U15-ES	L8-FS-S-12U15-ES	5/8"-24	10SL	12	16	3/8	9.0	0.31	68.0	2.68	24.0	0.94	20.0	0.79	25.4	1.00
L6-FS-S-17U18-ES	L8-FS-S-17U18-ES	3/4"-20	14SL	17	20	1/2	9.0	0.35	69.0	2.72	30.0	1.18	26.0	1.02	30.0	1.18
L6-FS-S-10U21-ES	L8-FS-S-10U21-ES	7/8"-20	16 / 16S	10	12	5/16	9.0	0.35	64.0	2.52	20.0	0.79	17.0	0.67	27.0	1.06
L6-FS-S-12U21-ES	L8-FS-S-12U21-ES	7/8"-20	16 / 16S	12	16	3/8	9.0	0.35	68.0	2.68	24.0	0.94	20.0	0.79	27.0	1.06
L6-FS-S-17U21-ES	L8-FS-S-17U21-ES	7/8"-20	16 / 16S	17	20	1/2	9.0	0.35	69.0	2.72	30.0	1.18	26.0	1.02	30.0	1.18
L6-FS-S-12U24-ES	L8-FS-S-12U24-ES	1"-20	18	12	16	3/8	9.0	0.35	68.0	2.68	24.0	0.94	20.0	0.79	29.4	1.16
L6-FS-S-17U24-ES	L8-FS-S-17U24-ES	1"-20	18	17	20	1/2	9.0	0.35	70.0	2.76	30.0	1.18	26.0	1.02	29.0	1.14
L6-FS-S-23U24-ES	L8-FS-S-23U24-ES	1"-20	18	23	25	3/4	9.0	0.35	79.0	3.11	38.0	1.50	32.0	1.26	36.0	1.42
L6-FS-S-12U27-ES	L8-FS-S-12U27-ES	1 1/8"-18	20	12	16	3/8	9.0	0.35	70.0	2.76	24.0	0.94	20.0	0.79	32.5	1.28
L6-FS-S-17U27-ES	L8-FS-S-17U27-ES	1 1/8"-18	20	17	20	1/2	9.0	0.35	70.0	2.76	30.0	1.18	26.0	1.02	32.5	1.28
L6-FS-S-23U27-ES	L8-FS-S-23U27-ES	1 1/8"-18	20	23	25	3/4	9.0	0.35	79.0	3.11	38.0	1.50	32.0	1.26	36.0	1.42
L6-FS-S-29U27-ES	L8-FS-S-29U27-ES	1 1/8"-18	20	29	32	1	9.0	0.35	86.0	3.39	45.5	1.79	40.0	1.57	44.4	1.75
L6-FS-S-12U30-ES	L8-FS-S-12U30-ES	1 1/4"-18	22	12	16	3/8	9.0	0.39	77.0	3.03	24.0	0.94	20.0	0.79	36.0	1.42
L6-FS-S-17U30-ES	L8-FS-S-17U30-ES	1 1/4"-18	22	17	20	1/2	9.0	0.39	77.0	3.03	30.0	1.18	26.0	1.02	36.0	1.42
L6-FS-S-23U30-ES	L8-FS-S-23U30-ES	1 1/4"-18	22	23	25	3/4	9.0	0.35	79.0	3.11	38.0	1.50	32.0	1.26	36.0	1.42
L6-FS-S-29U30-ES	L8-FS-S-29U30-ES	1 1/4"-18	22	29	32	1	9.0	0.35	82.0	3.23	45.5	1.79	40.0	1.57	44.4	1.75
L6-FS-S-36U30-ES	L8-FS-S-36U30-ES	1 1/4"-18	22	36	40	1-1/4	9.0	0.35	85.0	3.35	57.0	2.24	50.0	1.97	55.0	2.17
L6-FS-S-12U34-ES	L8-FS-S-12U34-ES	1 3/8"-18	24	12	16	3/8	9.0	0.39	77.0	3.03	24.0	0.94	20.0	0.79	39.0	1.54
L6-FS-S-17U34-ES	L8-FS-S-17U34-ES	1 3/8"-18	24	17	20	1/2	9.0	0.35	77.0	3.03	30.0	1.18	26.0	1.02	39.0	1.54
L6-FS-S-23U34-ES	L8-FS-S-23U34-ES	1 3/8"-18	24	23	25	3/4	9.0	0.35	79.0	3.11	38.0	1.50	32.0	1.26	39.0	1.54
L6-FS-S-29U34-ES	L8-FS-S-29U34-ES	1 3/8"-18	24	29	32	1	9.0	0.35	85.0	3.35	45.5	1.79	40.0	1.57	43.0	1.69
L6-FS-S-36U34-ES	L8-FS-S-36U34-ES	1 3/8"-18	24	36	40	1-1/4	9.0	0.35	90.0	3.54	57.0	2.24	50.0	1.97	50.8	2.00
L6-FS-S-17U40-ES	L8-FS-S-17U40-ES	1 5/8"-18	28	17	20	1/2	9.0	0.39	74.0	2.91	30.0	1.18	26.0	1.02	46.0	1.81
L6-FS-S-23U40-ES	L8-FS-S-23U40-ES	1 5/8"-18	28	23	25	3/4	9.0	0.39	85.0	3.35	38.0	1.50	32.0	1.26	46.0	1.81
L6-FS-S-29U40-ES	L8-FS-S-29U40-ES	1 5/8"-18	28	29	32	1	9.0	0.39	81.0	3.19	45.5	1.79	40.0	1.57	46.0	1.81
L6-FS-S-36U40-ES	L8-FS-S-36U40-ES	1 5/8"-18	28	36	40	1-1/4	9.0	0.39	92.0	3.62	57.0	2.24	50.0	1.97	50.8	2.00
L6-FS-S-23U47-ES	L8-FS-S-23U47-ES	1 7/8"-16	32	23	25	3/4	10.0	0.39	85.0	3.35	38.0	1.50	32.0	1.26	52.0	2.05
L6-FS-S-29U47-ES	L8-FS-S-29U47-ES	1 7/8"-16	32	29	32	1	10.0	0.39	85.0	3.35	45.5	1.79	40.0	1.57	54.0	2.13
L6-FS-S-36U47-ES	L8-FS-S-36U47-ES	1 7/8"-16	32	36	40	1-1/4	10.0	0.39	92.0	3.62	57.0	2.24	50.0	1.97	54.0	2.13
L6-FS-S-48U47-ES	L8-FS-S-48U47-ES	1 7/8"-16	32	48	50	1-1/2	10.0	0.39	100.0	3.94	68.0	2.68	64.0	2.52	63.5	2.50
L6-FS-S-23U53-ES	L8-FS-S-23U53-ES	2 1/16"-16	36	23	25	3/4	10.0	0.39	97.0	3.82	38.0	1.50	32.0	1.26	56.0	2.20
L6-FS-S-29U53-ES	L8-FS-S-29U53-ES	2 1/16"-16	36	29	32	1	10.0	0.39	97.0	3.82	45.5	1.79	40.0	1.57	58.0	2.28
L6-FS-S-36U53-ES	L8-FS-S-36U53-ES	2 1/16"-16	36	36	40	1-1/4	10.0	0.39	104.0	4.09	57.0	2.24	50.0	1.97	58.0	2.28
L6-FS-S-48U53-ES	L8-FS-S-48U53-ES	2 1/16"-16	36	48	50	1-1/2	10.0	0.39	112.0	4.41	68.0	2.68	64.0	2.52	63.5	2.50
L6-FS-S-23U57A-ES	L8-FS-S-23U57A-ES	2 5/16"-16	40	23	25	3/4	10.0	0.39	87.0	3.43	38.0	1.50	32.0	1.26	59.0	2.32
L6-FS-S-29U57A-ES	L8-FS-S-29U57A-ES	2 5/16"-16	40	29	32	1	10.0	0.39	87.0	3.43	45.5	1.79	40.0	1.57	61.0	2.40
L6-FS-S-36U57A-ES	L8-FS-S-36U57A-ES	2 5/16"-16	40	36	40	1-1/4	10.0	0.39	96.0	3.78	57.0	2.24	50.0	1.97	61.0	2.40
L6-FS-S-48U57A-ES	L8-FS-S-48U57A-ES	2 5/16"-16	40	48	50	1-1/2	10.0	0.39	101.0	3.98	68.0	2.68	64.0	2.52	63.5	2.50

UNEF METAL THREAD



- Locking device system provides a quick and secure push-in connection of corrugated conduits
- High-grade formulated polyamide, with black anodized aluminum thread
- Self-extinguishing, free from halogens and cadmium
- Temperature range: -40°C(-40°F) to 105°C(221°F), Short-term to 160°C(320°F)
- Up to IP68 / NEMA 6P protection with the reinforced sealing cap at conduit side
- Colour: Black standard, other colours available upon request

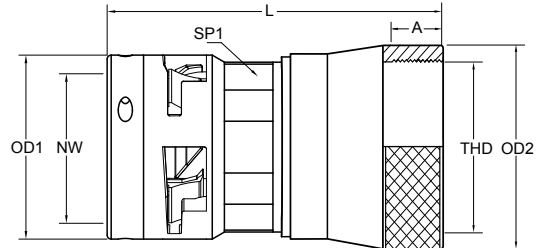
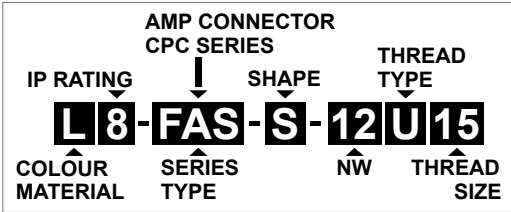

Specifications are subject to change without notice

UNEF METAL THREAD

Order No.	Order No.	THD	Fits to Conduit			A		L		OD1		SP1		OD2	
IP66	IP68	UNEF	NW	mm	in	mm	in	mm	in	mm	in	mm	in	mm	in
L6-FAS-S-10U15	L8-FAS-S-10U15	5/8"-24	10	12	5/16	8.0	0.31	51.0	2.01	20.0	0.79	17.0	0.67	23.5	0.93
L6-FAS-S-10U34	L8-FAS-S-10U34	1 3/8"-18	10	12	5/16	8.0	0.31	58.0	2.28	20.0	0.79	17.0	0.67	40.5	1.59
L6-FAS-S-12U15	L8-FAS-S-12U15	5/8"-24	12	16	3/8	8.0	0.31	56.0	2.20	24.0	0.94	20.0	0.79	25.4	1.00
L6-FAS-S-12U18	L8-FAS-S-12U18	3/4"-20	12	16	3/8	8.0	0.31	56.0	2.20	24.0	0.94	20.0	0.79	25.4	1.00
L6-FAS-S-17U18	L8-FAS-S-17U18	3/4"-20	17	20	1/2	8.0	0.31	57.5	2.26	30.0	1.18	26.0	1.02	30.0	1.18
L6-FAS-S-17U34	L8-FAS-S-17U34	1 3/8"-18	17	20	1/2	8.0	0.31	58.5	2.30	30.0	1.18	26.0	1.02	40.5	1.59
L6-FAS-S-23U18	L8-FAS-S-23U18	3/4"-20	23	25	3/4	8.0	0.31	72.0	2.83	38.0	1.50	32.0	1.26	40.5	1.59
L6-FAS-S-23U23	L8-FAS-S-23U23	15/16"-20	23	25	3/4	8.0	0.31	72.0	2.83	38.0	1.50	32.0	1.26	40.5	1.59
L6-FAS-S-23U35	L8-FAS-S-23U35	1 7/16"-18	23	25	3/4	8.0	0.31	72.0	2.83	38.0	1.50	32.0	1.26	40.5	1.59

LFBS Straight Swivel, Metal UNEF Thread, Polyamide Connector



- Locking device system provides a quick and secure push-in connection of corrugated conduits
- High-grade formulated polyamide, with black anodized aluminum thread
- Self-extinguishing, free from halogens and cadmium
- Temperature range: -40°C(-40°F) to 105°C(221°F), Short-term to 160°C(320°F)
- Up to IP68 / NEMA 6P protection with the reinforced sealing cap at conduit side
- Colour: Black standard, other colours available upon request

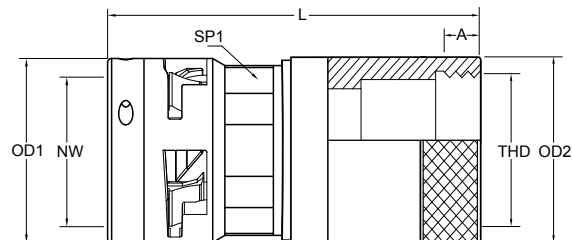
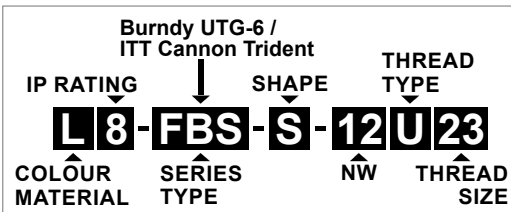

Specifications are subject to change without notice

UNEF METAL THREAD

Order No.	Order No.	THD	Fits to Conduit			A		L		OD1		SP1		OD2	
IP66	IP68	UNEF	NW	mm	in	mm	in	mm	in	mm	in	mm	in	mm	in
L6-FBS-S-12U16	L8-FBS-S-12U16	11/16"-24	12	16	3/8	4.0	0.16	61.0	2.40	24.0	0.94	20.0	0.79	24.0	0.94
L6-FBS-S-12U20	L8-FBS-S-12U20	13/16"-20	12	16	3/8	4.5	0.18	63.0	2.48	24.0	0.94	20.0	0.79	24.0	0.94
L6-FBS-S-12U26	L8-FBS-S-12U26	1 1/16"-18	12	16	3/8	4.5	0.18	66.0	2.60	24.0	0.94	20.0	0.79	31.0	1.22
L6-FBS-S-12U23	L8-FBS-S-12U23	15/16"-20	12	16	3/8	4.5	0.18	63.0	2.48	24.0	0.94	20.0	0.79	29.0	1.14
L6-FBS-S-17U26	L8-FBS-S-17U26	1 1/16"-18	17	20	1/2	4.5	0.18	64.0	2.52	30.0	1.18	26.0	1.02	31.0	1.22
L6-FBS-S-17U29	L8-FBS-S-17U29	1 3/16"-18	17	20	1/2	6.5	0.26	65.0	2.56	30.0	1.18	26.0	1.02	34.0	1.34
L6-FBS-S-23U29	L8-FBS-S-23U29	1 3/16"-18	23	25	3/4	6.5	0.26	70.0	2.76	38.0	1.50	32.0	1.26	36.0	1.42
L6-FBS-S-23U32	L8-FBS-S-23U32	1 5/16"-18	23	25	3/4	6.5	0.26	73.0	2.87	38.0	1.50	32.0	1.26	36.0	1.42
L6-FBS-S-23U35	L8-FBS-S-23U35	1 7/16"-18	23	25	3/4	6.5	0.26	70.0	2.76	38.0	1.50	32.0	1.26	40.5	1.59
L6-FBS-S-29U35	L8-FBS-S-29U35	1 7/16"-18	29	32	1	6.5	0.26	70.0	2.76	45.5	1.79	40.0	1.57	44.5	1.75

TEAFLEX



- Locking device system provides a quick and secure push-in connection of corrugated conduits
- High-grade formulated polyamide, with black anodized aluminum thread
- Self-extinguishing, free from halogens and cadmium
- Excellent impact strength
- Temperature range: -40°C(-40°F) to 105°C(221°F)
- Short-term to 160°C(320°F)
- Up to IP68 / NEMA 6P protection with the reinforced sealing cap at conduit side
- Colour: Black standard, other colours available upon request

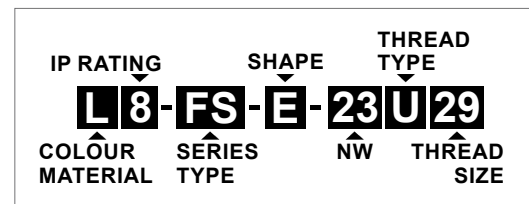
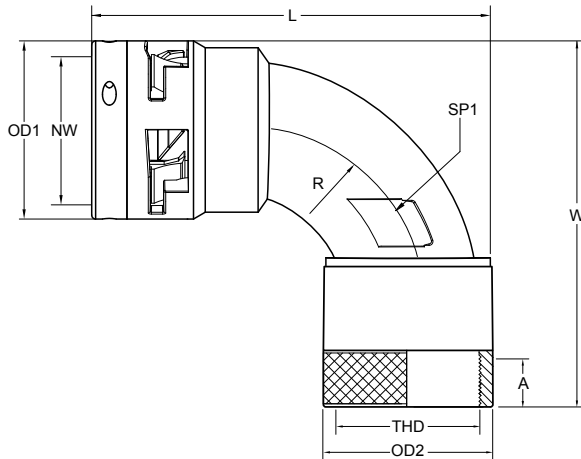

Specifications are subject to change without notice

Order No. IP66	Order No. IP68	THD UNEF	Fits to Conduit			A		L		R		W		OD1		SP1		OD2	
			NW	mm	in	mm	in	mm	in	mm	in	mm	in	mm	in	mm	in	mm	in
L6-FS-E-12U15	L8-FS-E-12U15	5/8"-24	12	16	3/8	8.0	0.31	65.0	2.56	31.7	1.25	56.3	2.22	24.0	0.94	15.0	0.59	25.4	1.00
L6-FS-E-17U18	L8-FS-E-17U18	3/4"-20	17	20	1/2	9.0	0.35	76.0	2.99	36.6	1.44	62.6	2.46	30.0	1.18	20.0	0.79	30.0	1.18
L6-FS-E-12U20	L8-FS-E-12U20	13/16"-20	12	16	3/8	9.0	0.35	65.6	2.58	31.7	1.25	59.3	2.33	24.0	0.94	15.0	0.59	25.4	1.00
L6-FS-E-10U21	L8-FS-E-10U21	7/8"-20	10	12	5/16	9.0	0.35	61.3	2.41	31.2	1.23	56.5	2.22	20.0	0.79	13.0	0.51	27.0	1.06
L6-FS-E-12U21	L8-FS-E-12U21	7/8"-20	12	16	3/8	9.0	0.35	76.3	3.00	31.7	1.25	59.3	2.33	24.0	0.94	15.0	0.59	27.0	1.06
L6-FS-E-17U21	L8-FS-E-17U21	7/8"-20	17	20	1/2	9.0	0.35	77.0	3.03	36.6	1.44	67.6	2.66	30.0	1.18	20.0	0.79	30.0	1.18
L6-FS-E-12U24	L8-FS-E-12U24	1"-20	12	16	3/8	9.0	0.35	65.0	2.56	31.7	1.25	59.3	2.33	24.0	0.94	15.0	0.59	29.4	1.16
L6-FS-E-17U24	L8-FS-E-17U24	1"-20	17	20	1/2	9.0	0.35	76.3	3.00	36.6	1.44	62.6	2.46	30.0	1.18	20.0	0.79	30.0	1.18
L6-FS-E-23U24	L8-FS-E-23U24	1"-20	23	25	3/4	9.0	0.35	90.0	3.54	41.5	1.63	73.9	2.91	38.0	1.50	26.0	1.02	36.0	1.42
L6-FS-E-12U29	L8-FS-E-12U29	1 3/16"-18	12	16	3/8	9.0	0.35	65.0	2.56	31.7	1.25	61.3	2.41	24.0	0.94	15.0	0.59	34.2	1.35
L6-FS-E-17U29	L8-FS-E-17U29	1 3/16"-18	17	20	1/2	9.0	0.35	76.0	2.99	36.6	1.44	67.6	2.66	30.0	1.18	20.0	0.79	34.2	1.35
L6-FS-E-23U29	L8-FS-E-23U29	1 3/16"-18	23	25	3/4	9.0	0.35	90.9	3.58	41.5	1.63	73.9	2.91	38.0	1.50	26.0	1.02	36.0	1.42
L6-FS-E-29U29	L8-FS-E-29U29	1 3/16"-18	29	32	1	9.0	0.35	101.8	4.01	41.5	1.63	89.0	3.50	45.5	1.79	32.0	1.26	44.4	1.75
L6-FS-E-12U35	L8-FS-E-12U35	1 7/16"-18	12	16	3/8	10.0	0.39	65.0	2.56	31.7	1.25	69.3	2.73	24.0	0.94	15.0	0.59	40.5	1.59
L6-FS-E-17U35	L8-FS-E-17U35	1 7/16"-18	17	20	1/2	9.0	0.35	76.0	2.99	36.6	1.44	71.6	2.82	30.0	1.18	20.0	0.79	40.5	1.59
L6-FS-E-23U35	L8-FS-E-23U35	1 7/16"-18	23	25	3/4	9.0	0.35	90.0	3.54	41.5	1.63	73.9	2.91	38.0	1.50	26.0	1.02	40.5	1.59
L6-FS-E-29U35	L8-FS-E-29U35	1 7/16"-18	29	32	1	9.0	0.35	102.8	4.05	41.5	1.63	85.0	3.35	45.5	1.79	32.0	1.26	44.4	1.75
L6-FS-E-36U35	L8-FS-E-36U35	1 7/16"-18	36	40	1-1/4	9.0	0.35	127.7	5.03	59.4	2.34	99.4	3.91	57.0	2.24	40.0	1.57	50.8	2.00
L6-FS-E-17U43	L8-FS-E-17U43	1 3/4"-18UNS	17	20	1/2	10.0	0.39	76.0	2.99	36.6	1.44	71.6	2.82	30.0	1.18	20.0	0.79	48.5	1.91
L6-FS-E-23U43	L8-FS-E-23U43	1 3/4"-18UNS	23	25	3/4	10.0	0.39	90.0	3.54	41.5	1.63	82.0	3.23	38.0	1.50	26.0	1.02	48.5	1.91
L6-FS-E-29U43	L8-FS-E-29U43	1 3/4"-18UNS	29	32	1	10.0	0.39	101.8	4.01	41.5	1.63	86.0	3.39	45.5	1.79	32.0	1.26	50.5	1.99
L6-FS-E-36U43	L8-FS-E-36U43	1 3/4"-18UNS	36	40	1-1/4	10.0	0.39	123.5	4.86	59.4	2.34	100.4	3.95	57.0	2.24	40.0	1.57	50.8	2.00
L6-FS-E-23U50	L8-FS-E-23U50	2"-18UNS	23	25	3/4	10.0	0.39	90.0	3.54	41.5	1.63	80.0	3.15	38.0	1.50	26.0	1.02	54.8	2.16
L6-FS-E-29U50	L8-FS-E-29U50	2"-18UNS	29	32	1	10.0	0.39	101.8	4.01	41.5	1.63	86.0	3.39	45.5	1.79	32.0	1.26	56.8	2.24
L6-FS-E-36U50	L8-FS-E-36U50	2"-18UNS	36	40	1-1/4	10.0	0.39	123.5	4.86	59.4	2.34	100.4	3.95	57.0	2.24	40.0	1.57	56.8	2.24
L6-FS-E-48U50	L8-FS-E-48U50	2"-18UNS	48	50	1-1/2	10.0	0.39	147.1	5.79	63.3	2.49	102.4	4.03	68.0	2.68	55.0	2.17	66.0	2.60
L6-FS-E-23U56	L8-FS-E-23U56	2 1/4"-16UN	23	25	3/4	10.0	0.39	90.0	3.54	41.5	1.63	81.9	3.22	38.0	1.50	26.0	1.02	61.2	2.41
L6-FS-E-29U56	L8-FS-E-29U56	2 1/4"-16UN	29	32	1	10.0	0.39	101.8	4.01	41.5	1.63	89.0	3.50	45.5	1.79	32.0	1.26	63.5	2.50
L6-FS-E-36U56	L8-FS-E-36U56	2 1/4"-16UN	36	40	1-1/4	10.0	0.39	123.5	4.86	59.4	2.34	104.4	4.11	57.0	2.24	40.0	1.57	63.5	2.50
L6-FS-E-48U56	L8-FS-E-48U56	2 1/4"-16UN	48	50	1-1/2	10.0	0.39	143.8	5.66	63.3	2.49	112.4	4.43	68.0	2.68	55.0	2.17	66.0	2.60

UNEF METAL THREAD

TEAFLEX



- Locking device system provides a quick and secure push-in connection of corrugated conduits
- High-grade formulated polyamide, with black anodized aluminum thread
- Self-extinguishing, free from halogens and cadmium
- Excellent impact strength
- Temperature range: -40°C(-40°F) to 105°C(221°F)
- Short-term to 160°C(320°F)
- Up to IP68 / NEMA 6P protection with the reinforced sealing cap at conduit side
- Colour: Black standard, other colours available upon request

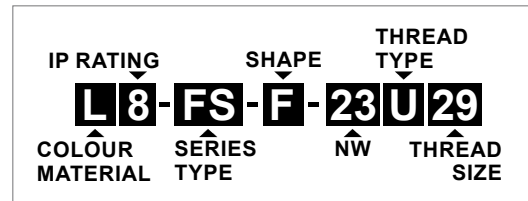
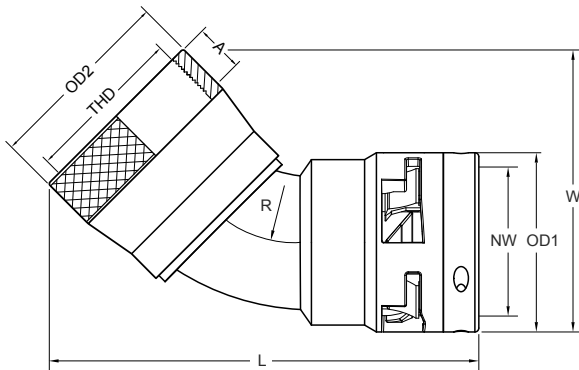

Specifications are subject to change without notice

UNEF METAL THREAD

Order No.	Order No.	THD	Fits to Conduit			A		L		R		W		OD1		OD2	
IP66	IP68	UNEF	NW	mm	in	mm	in	mm	in	mm	in	mm	in	mm	in	mm	in
L6-FS-F-12U15	L8-FS-F-12U15	5/8"-24	12	16	3/8	8.0	0.31	67.5	2.66	31.6	1.24	39.3	1.55	24.0	0.94	25.4	1.00
L6-FS-F-17U18	L8-FS-F-17U18	3/4"-20	17	20	1/2	9.0	0.35	76.8	3.02	37.6	1.48	44.0	1.73	30.0	1.18	30.0	1.18
L6-FS-F-10U21	L8-FS-F-10U21	7/8"-20	10	12	5/16	9.0	0.35	67.2	2.65	31.2	1.23	38.7	1.52	20.0	0.79	27.0	1.06
L6-FS-F-12U21	L8-FS-F-12U21	7/8"-20	12	16	3/8	9.0	0.35	70.6	2.78	31.6	1.24	42.4	1.67	24.0	0.94	27.0	1.06
L6-FS-F-17U21	L8-FS-F-17U21	7/8"-20	17	20	1/2	9.0	0.35	78.6	3.09	37.6	1.48	45.7	1.80	30.0	1.18	30.0	1.18
L6-FS-F-12U24	L8-FS-F-12U24	1"-20	12	16	3/8	9.0	0.35	71.4	2.81	31.6	1.24	43.3	1.70	24.0	0.94	29.4	1.16
L6-FS-F-17U24	L8-FS-F-17U24	1"-20	17	20	1/2	9.0	0.35	79.3	3.12	37.6	1.48	46.4	1.83	30.0	1.18	30.0	1.18
L6-FS-F-23U24	L8-FS-F-23U24	1"-20	23	25	3/4	9.0	0.35	88.7	3.49	41.5	1.63	52.3	2.06	38.0	1.50	36.0	1.42
L6-FS-F-12U29	L8-FS-F-12U29	1 3/16"-18	12	16	3/8	9.0	0.35	74.5	2.93	31.6	1.24	46.4	1.83	24.0	0.94	34.2	1.35
L6-FS-F-17U29	L8-FS-F-17U29	1 3/16"-18	17	20	1/2	9.0	0.35	80.7	3.18	37.6	1.48	47.8	1.88	30.0	1.18	34.2	1.35
L6-FS-F-23U29	L8-FS-F-23U29	1 3/16"-18	23	25	3/4	9.0	0.35	90.4	3.56	41.5	1.63	54.0	2.13	38.0	1.50	36.0	1.42
L6-FS-F-29U29	L8-FS-F-29U29	1 3/16"-18	29	32	1	9.0	0.35	100.1	3.94	47.5	1.87	62.8	2.47	45.5	1.79	44.4	1.75
L6-FS-F-12U35	L8-FS-F-12U35	1 7/16"-18	12	16	3/8	10.0	0.39	82.4	3.24	31.6	1.24	54.3	2.14	24.0	0.94	40.5	1.59
L6-FS-F-17U35	L8-FS-F-17U35	1 7/16"-18	17	20	1/2	9.0	0.35	85.8	3.38	37.6	1.48	52.9	2.08	30.0	1.18	40.5	1.59
L6-FS-F-23U35	L8-FS-F-23U35	1 7/16"-18	23	25	3/4	9.0	0.35	92.6	3.65	41.5	1.63	56.2	2.21	38.0	1.50	40.5	1.59
L6-FS-F-29U35	L8-FS-F-29U35	1 7/16"-18	29	32	1	9.0	0.35	99.5	3.92	47.5	1.87	62.1	2.44	45.5	1.79	44.4	1.75
L6-FS-F-36U35	L8-FS-F-36U35	1 7/16"-18	36	40	1-1/4	9.0	0.35	111.3	4.38	59.4	2.34	69.8	2.75	57.0	2.24	50.8	2.00
L6-FS-F-17U43	L8-FS-F-17U43	1 3/4"-18UNS	17	20	1/2	10.0	0.39	88.6	3.49	37.6	1.48	55.8	2.20	30.0	1.18	48.5	1.91
L6-FS-F-23U43	L8-FS-F-23U43	1 3/4"-18UNS	23	25	3/4	10.0	0.39	99.7	3.93	41.5	1.63	63.3	2.49	38.0	1.50	48.5	1.91
L6-FS-F-29U43	L8-FS-F-29U43	1 3/4"-18UNS	29	32	1	10.0	0.39	103.1	4.06	47.5	1.87	65.7	2.59	45.5	1.79	50.5	1.99
L6-FS-F-36U43	L8-FS-F-36U43	1 3/4"-18UNS	36	40	1-1/4	10.0	0.39	114.9	4.52	59.4	2.34	73.4	2.89	57.0	2.24	50.8	2.00
L6-FS-F-23U50	L8-FS-F-23U50	2"-18UNS	23	25	3/4	10.0	0.39	101.9	4.01	41.5	1.63	65.5	2.58	38.0	1.50	54.8	2.16
L6-FS-F-29U50	L8-FS-F-29U50	2"-18UNS	29	32	1	10.0	0.39	105.3	4.15	47.5	1.87	67.9	2.67	45.5	1.79	56.8	2.24
L6-FS-F-36U50	L8-FS-F-36U50	2"-18UNS	36	40	1-1/4	10.0	0.39	117.0	4.61	59.4	2.34	75.5	2.97	57.0	2.24	56.8	2.24
L6-FS-F-48U50	L8-FS-F-48U50	2"-18UNS	48	50	1-1/2	10.0	0.39	132.6	5.22	63.3	2.49	84.8	3.34	68.0	2.68	66.0	2.60
L6-FS-F-23U56	L8-FS-F-23U56	2 1/4"-16UN	23	25	3/4	10.0	0.39	105.6	4.16	41.5	1.63	69.2	2.72	38.0	1.50	61.2	2.41
L6-FS-F-29U56	L8-FS-F-29U56	2 1/4"-16UN	29	32	1	10.0	0.39	109.8	4.32	47.5	1.87	72.4	2.85	45.5	1.79	63.5	2.50
L6-FS-F-36U56	L8-FS-F-36U56	2 1/4"-16UN	36	40	1-1/4	10.0	0.39	122.2	4.81	59.4	2.34	80.7	3.18	57.0	2.24	63.5	2.50
L6-FS-F-48U56	L8-FS-F-48U56	2 1/4"-16UN	48	50	1-1/2	10.0	0.39	135.0	5.31	63.3	2.49	87.2	3.43	68.0	2.68	66.0	2.60



- Locking device system provides a quick and secure push-in connection of corrugated conduits
- High-grade formulated polyamide
- EMI/EMC end made of nickel-plated aluminum
- Low transfer impedances
- 360° clamping effect: For high shielding efficiency
- Self-extinguishing, free from halogens and cadmium
- Excellent impact strength
- Temperature range: -40°C(-40°F) to 105°C(221°F)
- Short-term to 160°C(320°F)
- Up to IP68 / NEMA 6P protection with the reinforced sealing cap at conduit side

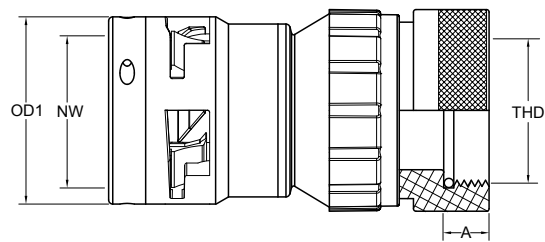
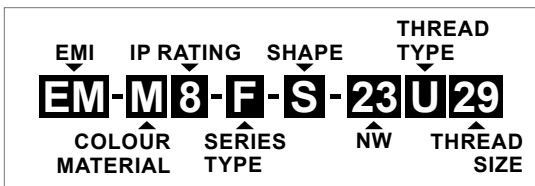

Specifications are subject to change without notice

Order No.	THD UNEF	Fits to	Fits to	A		OD1	
		NW	Braid	mm	in	mm	in
EM-M8-F-S-10U15	5/8"-24	10	BCU-10F	8.0	0.31	20.0	0.79
EM-M8-F-S-12U15	5/8"-24	12	BCU-10F	8.0	0.31	24.0	0.94
EM-M8-F-S-12U16	11/16"-24	12	BCU-10F	8.0	0.31	24.0	0.94
EM-M8-F-S-12U18	3/4"-20	12	BCU-10F	9.0	0.35	24.0	0.94
EM-M8-F-S-17U18	3/4"-20	17	BCU-15F	9.0	0.35	30.0	1.18
EM-M8-F-S-12U21	7/8"-20	12	BCU-10F	9.0	0.35	24.0	0.94
EM-M8-F-S-17U21	7/8"-20	17	BCU-15F	9.0	0.35	30.0	1.18
EM-M8-F-S-23U21	7/8"-20	23	BCU-15F	9.0	0.35	38.0	1.50
EM-M8-F-S-12U24	1"-20	12	BCU-10F	9.0	0.35	24.0	0.94
EM-M8-F-S-17U24	1"-20	17	BCU-15F	9.0	0.35	30.0	1.18
EM-M8-F-S-23U24	1"-20	23	BCU-15F	9.0	0.35	38.0	1.50
EM-M8-F-S-12U29	1-3/16"-18	12	BCU-10F	9.0	0.35	24.0	0.94
EM-M8-F-S-17U29	1-3/16"-18	17	BCU-15F	9.0	0.35	30.0	1.18
EM-M8-F-S-23U29	1-3/16"-18	23	BCU-15F	9.0	0.35	38.0	1.50
EM-M8-F-S-29U29	1-3/16"-18	29	BCU-20F	9.0	0.35	45.5	1.79
EM-M8-F-S-17U35	1-7/16"-18	17	BCU-15F	9.0	0.35	30.0	1.18
EM-M8-F-S-23U35	1-7/16"-18	23	BCU-15F	9.0	0.35	38.0	1.50
EM-M8-F-S-29U35	1-7/16"-18	29	BCU-20F	9.0	0.35	45.5	1.79
EM-M8-F-S-36U35	1-7/16"-18	36	BCU-40F	9.0	0.35	57.0	2.24
EM-M8-F-S-23U40	1-5/8"-18 UNS	23	BCU-15F	9.0	0.35	38.0	1.50
EM-M8-F-S-29U40	1-5/8"-18 UNS	29	BCU-20F	9.0	0.35	45.5	1.79
EM-M8-F-S-17U43	1-3/4"-18 UNS	17	BCU-15F	10.0	0.39	30.0	1.18
EM-M8-F-S-23U43	1-3/4"-18 UNS	23	BCU-15F	10.0	0.39	38.0	1.50
EM-M8-F-S-29U43	1-3/4"-18 UNS	29	BCU-20F	10.0	0.39	45.5	1.79
EM-M8-F-S-36U43	1-3/4"-18 UNS	36	BCU-40F	10.0	0.39	57.0	2.24
EM-M8-F-S-48U43	1-3/4"-18 UNS	48	BCU-40F	10.0	0.39	68.0	2.68
EM-M8-F-S-23U50	2"-18 UNS	23	BCU-15F	10.0	0.39	38.0	1.50
EM-M8-F-S-29U50	2"-18 UNS	29	BCU-20F	10.0	0.39	45.5	1.79
EM-M8-F-S-36U50	2"-18 UNS	36	BCU-40F	10.0	0.39	57.0	2.24
EM-M8-F-S-48U50	2"-18 UNS	48	BCU-40F	10.0	0.39	68.0	2.68
EM-M8-F-S-23U56	2-1/4"-16 UN	23	BCU-15F	10.0	0.39	38.0	1.50
EM-M8-F-S-29U56	2-1/4"-16 UN	29	BCU-20F	10.0	0.39	45.5	1.79
EM-M8-F-S-36U56	2-1/4"-16 UN	36	BCU-40F	10.0	0.39	57.0	2.24
EM-M8-F-S-48U56	2-1/4"-16 UN	48	BCU-40F	10.0	0.39	68.0	2.68

UNEF METAL THREAD

TEAFLEX



ACCORDING TO
MIL-DTL-5015/VG-95234
CIRCULAR CONNECTORS

- Designed to thread directly onto circular connectors & houses environmental seal
- Locking device system provides a quick and secure push-in connection of corrugated conduits
- High-grade formulated polyamide
- EMI/EMC end made of nickel-plated aluminum
- Low transfer impedances
- 360° clamping effect: For high shielding efficiency
- Self-extinguishing, free from halogens and cadmium
- Excellent impact strength
- Temperature range: -40°C(-40°F) to 105°C(221°F), Short-term to 160°C(320°F)
- Up to IP68 / NEMA 6P protection with the reinforced sealing cap at conduit side

EMI	IP RATING	SHAPE	THREAD TYPE	ENVIRO SEAL
EM	M8	F-S	23U30	ES
COLOUR MATERIAL	SERIES TYPE	NW	THREAD SIZE	

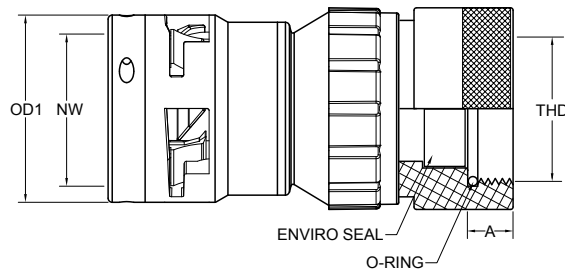

Specifications are subject to change without notice

UNEF METAL THREAD

Order No.	THD	Shell Size	Fits to	Fits to Conduit		A		OD1		
				NW	mm	in	mm	in	mm	in
IP68		UNEF	MIL-C5015	Braid						
EM-M8-F-S-10U15-ES	5/8"-24	10SL	BCU-10F	10	12	5/16	9.0	0.31	20.0	0.79
EM-M8-F-S-12U15-ES	5/8"-24	10SL	BCU-10F	12	16	3/8	9.0	0.31	24.0	0.94
EM-M8-F-S-17U18-ES	3/4"-20	14SL	BCU-15F	17	20	1/2	9.0	0.35	30.0	1.18
EM-M8-F-S-10U21-ES	7/8"-20	16 / 16S	BCU-10F	10	12	5/16	9.0	0.35	20.0	0.79
EM-M8-F-S-12U21-ES	7/8"-20	16 / 16S	BCU-10F	12	16	3/8	9.0	0.35	24.0	0.94
EM-M8-F-S-17U21-ES	7/8"-20	16 / 16S	BCU-15F	17	20	1/2	9.0	0.35	30.0	1.18
EM-M8-F-S-12U24-ES	1"-20	18	BCU-10F	12	16	3/8	9.0	0.35	24.0	0.94
EM-M8-F-S-17U24-ES	1"-20	18	BCU-15F	17	20	1/2	9.0	0.35	30.0	1.18
EM-M8-F-S-23U24-ES	1"-20	18	BCU-15F	23	25	3/4	9.0	0.35	38.0	1.50
EM-M8-F-S-12U27-ES	1 1/8"-18	20	BCU-10F	12	16	3/8	9.0	0.35	24.0	0.94
EM-M8-F-S-17U27-ES	1 1/8"-18	20	BCU-15F	17	20	1/2	9.0	0.35	30.0	1.18
EM-M8-F-S-23U27-ES	1 1/8"-18	20	BCU-15F	23	25	3/4	9.0	0.35	38.0	1.50
EM-M8-F-S-29U27-ES	1 1/8"-18	20	BCU-20F	29	32	1	9.0	0.35	45.5	1.79
EM-M8-F-S-12U30-ES	1 1/4"-18	22	BCU-10F	12	16	3/8	9.0	0.39	24.0	0.94
EM-M8-F-S-17U30-ES	1 1/4"-18	22	BCU-15F	17	20	1/2	9.0	0.35	30.0	1.18
EM-M8-F-S-23U30-ES	1 1/4"-18	22	BCU-15F	23	25	3/4	9.0	0.35	38.0	1.50
EM-M8-F-S-29U30-ES	1 1/4"-18	22	BCU-20F	29	32	1	9.0	0.35	45.5	1.79
EM-M8-F-S-36U30-ES	1 1/4"-18	22	BCU-40F	36	40	1-1/4	9.0	0.35	57.0	2.24
EM-M8-F-S-12U34-ES	1 3/8"-18	24	BCU-10F	12	16	3/8	9.0	0.39	24.0	0.94
EM-M8-F-S-17U34-ES	1 3/8"-18	24	BCU-15F	17	20	1/2	9.0	0.35	30.0	1.18
EM-M8-F-S-23U34-ES	1 3/8"-18	24	BCU-15F	23	25	3/4	9.0	0.35	38.0	1.50
EM-M8-F-S-29U34-ES	1 3/8"-18	24	BCU-20F	29	32	1	9.0	0.35	45.5	1.79
EM-M8-F-S-36U34-ES	1 3/8"-18	24	BCU-40F	36	40	1-1/4	9.0	0.35	57.0	2.24
EM-M8-F-S-17U40-ES	1 5/8"-18	28	BCU-15F	17	20	1/2	9.0	0.39	30.0	1.18
EM-M8-F-S-23U40-ES	1 5/8"-18	28	BCU-15F	23	25	3/4	9.0	0.39	38.0	1.50
EM-M8-F-S-29U40-ES	1 5/8"-18	28	BCU-20F	29	32	1	9.0	0.39	45.5	1.79
EM-M8-F-S-36U40-ES	1 5/8"-18	28	BCU-40F	36	40	1-1/4	9.0	0.39	57.0	2.24
EM-M8-F-S-23U47-ES	1 7/8"-16	32	BCU-15F	23	25	3/4	10.0	0.39	38.0	1.50
EM-M8-F-S-29U47-ES	1 7/8"-16	32	BCU-20F	29	32	1	10.0	0.39	45.5	1.79
EM-M8-F-S-36U47-ES	1 7/8"-16	32	BCU-40F	36	40	1-1/4	10.0	0.39	57.0	2.24
EM-M8-F-S-48U47-ES	1 7/8"-16	32	BCU-40F	48	50	1-1/2	10.0	0.39	68.0	2.68
EM-M8-F-S-23U53-ES	2 1/16"-16	36	BCU-15F	23	25	3/4	10.0	0.39	38.0	1.50
EM-M8-F-S-29U53-ES	2 1/16"-16	36	BCU-20F	29	32	1	10.0	0.39	45.5	1.79
EM-M8-F-S-36U53-ES	2 1/16"-16	36	BCU-40F	36	40	1-1/4	10.0	0.39	57.0	2.24
EM-M8-F-S-48U53-ES	2 1/16"-16	36	BCU-40F	48	50	1-1/2	10.0	0.39	68.0	2.68
EM-M8-F-S-23U57A-ES	2 5/16"-16	40	BCU-15F	23	25	3/4	10.0	0.39	38.0	1.50
EM-M8-F-S-29U57A-ES	2 5/16"-16	40	BCU-20F	29	32	1	10.0	0.39	45.5	1.79
EM-M8-F-S-36U57A-ES	2 5/16"-16	40	BCU-40F	36	40	1-1/4	10.0	0.39	57.0	2.24
EM-M8-F-S-48U57A-ES	2 5/16"-16	40	BCU-40F	48	50	1-1/2	10.0	0.39	68.0	2.68



- Locking device system provides a quick and secure push-in connection of corrugated conduits
- High-grade formulated polyamide
- EMI/EMC end made of nickel-plated aluminum
- Low transfer impedances
- 360° clamping effect: For high shielding efficiency
- Self-extinguishing, free from halogens and cadmium
- Excellent impact strength
- Temperature range: -40°C(-40°F) to 105°C(221°F)
- Short-term to 160°C(320°F)
- Up to IP68 / NEMA 6P protection with the reinforced sealing cap at conduit side

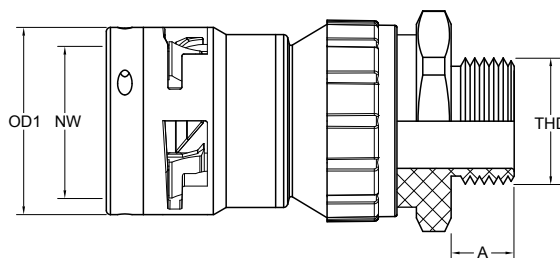
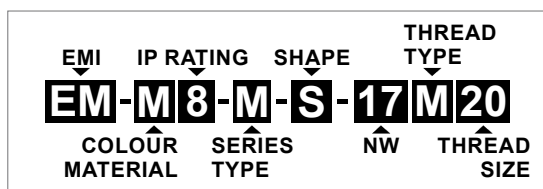

Specifications are subject to change without notice

METRIC METAL THREAD

Order No.	THD Metric	Fits to		A		OD1	
		NW	Braid	mm	in	mm	in
EM-M8-M-S-10M16	M16x1.5	10	BCU-10F	10.0	0.39	20.0	0.79
EM-M8-M-S-12M16	M16x1.5	12	BCU-10F	10.0	0.39	24.0	0.94
EM-M8-M-S-17M20	M20x1.5	17	BCU-15F	10.0	0.39	30.0	1.18
EM-M8-M-S-17M25	M25x1.5	17	BCU-15F	10.0	0.39	30.0	1.18
EM-M8-M-S-17M32	M32x1.5	17	BCU-15F	13.0	0.51	30.0	1.18
EM-M8-M-S-23M20	M20x1.5	23	BCU-15F	15.0	0.59	38.0	1.50
EM-M8-M-S-23M25	M25x1.5	23	BCU-15F	15.0	0.59	38.0	1.50
EM-M8-M-S-23M32	M32x1.5	23	BCU-15F	15.0	0.59	38.0	1.50
EM-M8-M-S-23M40	M40x1.5	23	BCU-15F	15.0	0.59	38.0	1.50
EM-M8-M-S-29M32	M32x1.5	29	BCU-20F	15.0	0.59	45.5	1.79
EM-M8-M-S-36M40	M40x1.5	36	BCU-40F	15.0	0.59	57.0	2.24
EM-M8-M-S-36M50	M50x1.5	36	BCU-40F	14.0	0.55	57.0	2.24
EM-M8-M-S-48M50	M50x1.5	48	BCU-40F	12.0	0.47	68.0	2.68
EM-M8-M-S-48M63	M63x1.5	48	BCU-40F	12.0	0.47	68.0	2.68



- Locking device system provides a quick and secure push-in connection of corrugated conduits
- High-grade formulated polyamide
- EMI/EMC end made of nickel-plated aluminum
- Low transfer impedances
- 360° clamping effect: For high shielding efficiency
- Self-extinguishing, free from halogens and cadmium
- Excellent impact strength
- Temperature range: -40°C(-40°F) to 105°C(221°F)
- Short-term to 160°C(320°F)
- Up to IP68 / NEMA 6P protection with the reinforced sealing cap at conduit side

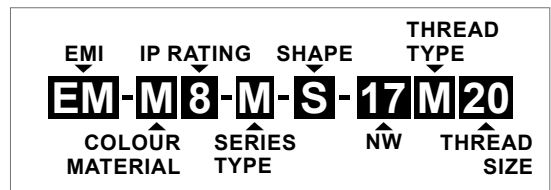
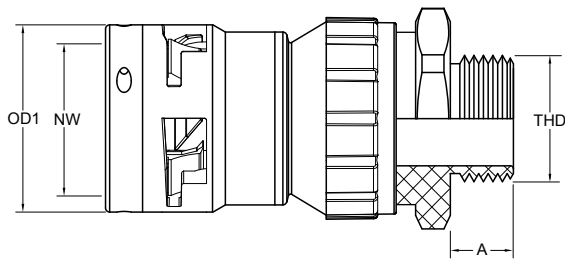

Specifications are subject to change without notice

NPT METAL THREAD

Order No.	THD NPT	Fits to		A		OD1	
		NW	Braid	mm	in	mm	in
EM-M8-M-S-10N01	3/8	10	BCU-10F	11.0	0.43	20.0	0.79
EM-M8-M-S-12N01	3/8	12	BCU-10F	11.0	0.43	24.0	0.94
EM-M8-M-S-12N02	1/2	12	BCU-10F	15.0	0.59	24.0	0.94
EM-M8-M-S-17N02	1/2	17	BCU-15F	13.0	0.51	30.0	1.18
EM-M8-M-S-23N04	3/4	23	BCU-15F	14.5	0.57	38.0	1.50
EM-M8-M-S-29N06	1	29	BCU-20F	15.0	0.59	45.5	1.79
EM-M8-M-S-36N07	1-1/4	36	BCU-40F	20.0	0.79	57.0	2.24
EM-M8-M-S-36N08	1-1/2	36	BCU-40F	18.2	0.72	57.0	2.24
EM-M8-M-S-48N08	1-1/2	48	BCU-40F	18.4	0.72	68.0	2.68
EM-M8-M-S-48N09	2	48	BCU-40F	18.3	0.72	68.0	2.68

PG METAL THREAD

Order No.	THD PG	Fits to		A		OD1	
		NW	Braid	mm	in	mm	in
EM-M8-M-S-10P09	9	10	BCU-10F	12.0	0.47	20.0	0.79
EM-M8-M-S-10P11	11	10	BCU-10F	12.0	0.47	20.0	0.79
EM-M8-M-S-12P11	11	12	BCU-10F	12.0	0.47	24.0	0.94
EM-M8-M-S-12P13	13.5	12	BCU-10F	13.0	0.51	24.0	0.94
EM-M8-M-S-17P16	16	17	BCU-15F	13.0	0.51	30.0	1.18
EM-M8-M-S-17P21	21	17	BCU-15F	14.0	0.55	30.0	1.18
EM-M8-M-S-23P21	21	23	BCU-15F	14.0	0.55	38.0	1.50
EM-M8-M-S-29P29	29	29	BCU-20F	14.0	0.55	45.5	1.79
EM-M8-M-S-36P36	36	36	BCU-40F	15.0	0.59	57.0	2.24
EM-M8-M-S-36P48	36	36	BCU-40F	15.0	0.59	57.0	2.24
EM-M8-M-S-48P48	48	48	BCU-40F	17.0	0.67	68.0	2.68

Adapters connect two differing parts to perform a given function safely and effectively. Our specialized parts span from simple transition and conversion adapters to complex swivel fittings. Common adapters have a male (external) to female (internal) thread combination although, customized arrangements are also available (see style C & D).

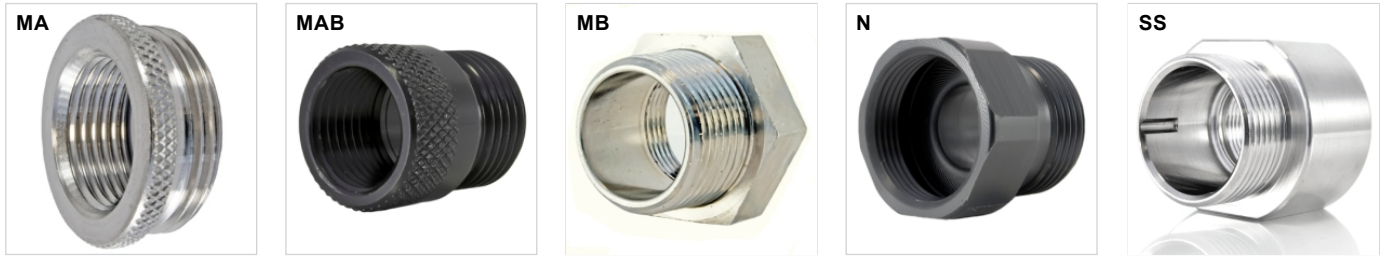

BODY STYLE

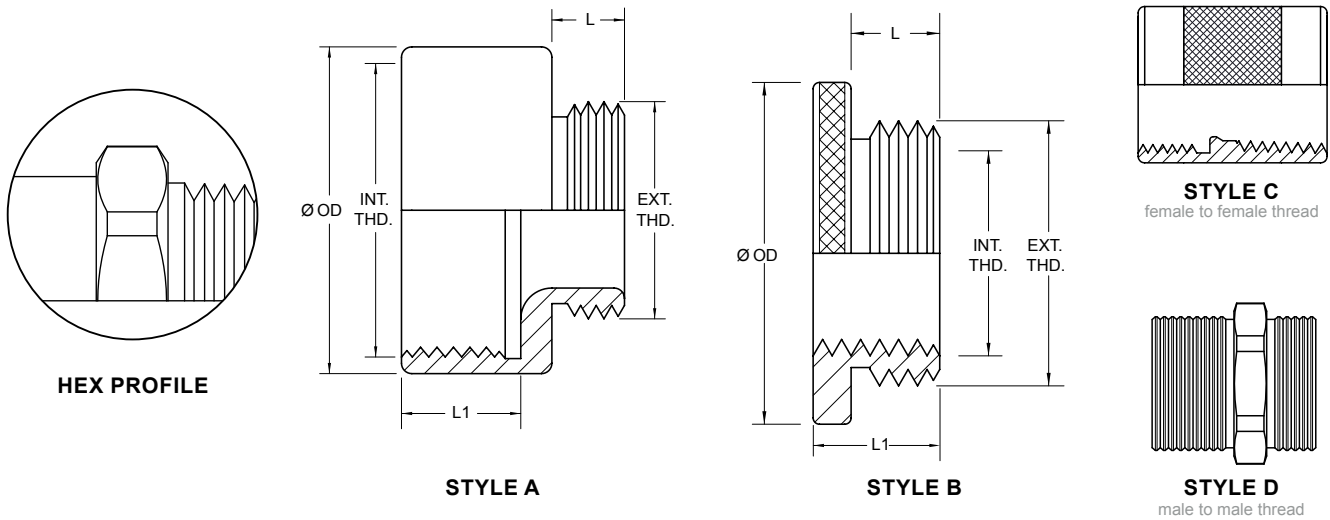

Specifications are subject to change without notice

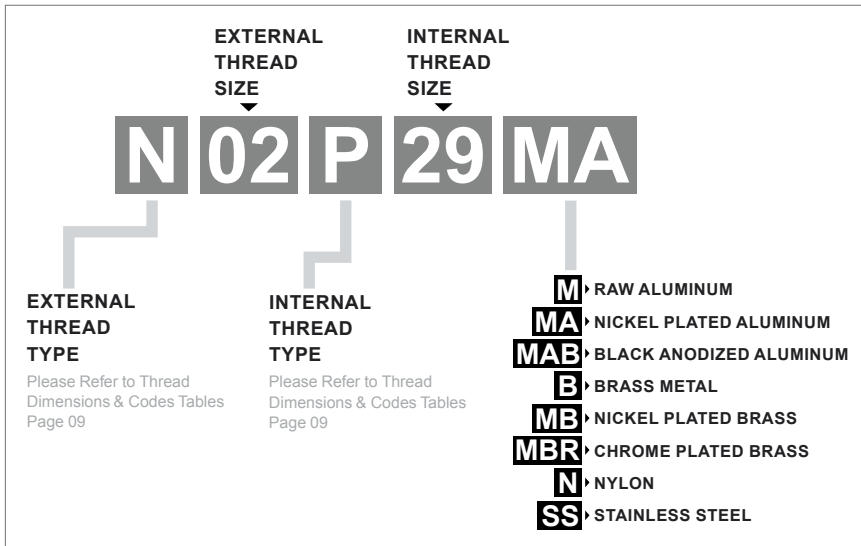

- Body Style
- Adding Hex. Profile
- External Thread Type
- Internal Thread Type
- External Thread Length
- Internal Thread Length
- Adapter Material
- Surface Treatment

For more standard adapters information <http://www.moltecinternational.com/products/accessories/enl-red.html>

Standard Bayonet Ring Connector (INDOORS)

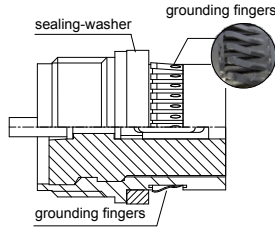

Size	N Thread (Inches)
10SL	5/8"-24 UNEF 2A
14SL	3/4"-20 UNEF 2A
16	7/8"-20 UNEF 2A
16S	7/8"-20 UNEF 2A
18	1"-20 UNEF 2A
20	1-1/8"-18 UNEF 2A
22	1-1/4"-18 UNEF 2A
24	1-3/8"-18 UNEF 2A
28	1-5/8"-18 UNEF 2A
32	1-7/8"-16 UN 2A
36	2-1/16"-16 UN 2A
40	2-5/16"-16 UN 2A



ACCORDING TO
MIL-DTL-5015/VG-95234
CIRCULAR CONNECTORS

- Aluminum Plug
- Shell with bayonet-ring
- Contact layouts available up to 85 contacts
- Cable cross-sections of 0.5 up to 50 mm²
- High mechanical loading capacity
- Resistant against fuels, and insulating oils
- Lifespan of minimum 500 mating cycles
- Elastic insert for pressed in crimp contacts
- Integrated waved ring spring
- EMI (Grounding Fingers)

Detailed technical specifications: <http://www.moltecinternational.com/datasheets/plugs.pdf>

Rubber Coated Bayonet Ring Connector (OUTDOORS)

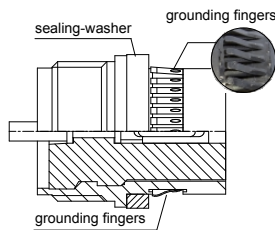

Size	N Thread (Inches)
18	1"-20 UNEF 2A
24	1-3/8"-18 UNEF 2A
32	1-7/8"-16 UN 2A
36	2-1/16"-16 UN 2A
40	2-5/16"-16 UN 2A



ACCORDING TO
MIL-DTL-5015/VG-95234
CIRCULAR CONNECTORS

- Aluminum Plug
- Shell with bayonet-ring
- Contact layouts available up to 85 contacts
- Cable cross-sections of 0.5 up to 50 mm²
- High mechanical loading capacity
- Resistant against fuels, and insulating oils
- Lifespan of minimum 500 mating cycles
- Elastic insert for pressed in crimp contacts
- Integrated waved ring spring
- EMI (Grounding Fingers)

Detailed technical specifications: <http://www.moltecinternational.com/datasheets/plugs.pdf>

Short Rubber Coated Connector (OUTDOORS)

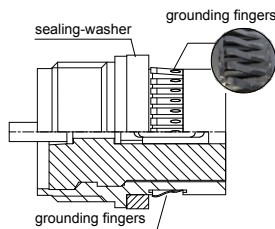

Size	N Thread (Inches)
10SL	5/8"-24 UNEF 2A
14S	3/4"-20 UNEF 2A
18	1"-20 UNEF 2A
20	1-1/8"-18 UNEF 2A
22	1-1/4"-18 UNEF 2A
24	1-3/8"-18 UNEF 2A
28	1-5/8"-18 UNEF 2A
32	1-7/8"-16 UN 2A
36	2-1/16"-16 UN 2A
40	2-5/16"-16 UN 2A



ACCORDING TO
MIL-DTL-5015/VG-95234
CIRCULAR CONNECTORS

- Aluminum Plug
- Shell with bayonet-ring
- Contact layouts available up to 85 contacts
- Cable cross-sections of 0.5 up to 50 mm²
- High mechanical loading capacity
- Resistant against fuels, and insulating oils
- Lifespan of minimum 500 mating cycles
- Elastic insert for pressed in crimp contacts
- Integrated waved ring spring
- EMI (Grounding Fingers)

Detailed technical specifications: <http://www.moltecinternational.com/datasheets/plugs.pdf>



ACCORDING TO
MIL-DTL-5015/VG-95234
CIRCULAR CONNECTORS

- Aluminum Receptacle
- Contact layouts available up to 85 contacts
- Cable cross-sections of 0.5 up to 50 mm²
- High mechanical loading capacity
- Resistant against fuels & insulating oils
- Lifespan of minimum 500 mating cycles
- Elastic insert for pressed in crimp contacts

Size	N Thread (Inches)
10SL	5/8"-24 UNEF 2A
14S	3/4"-20 UNEF 2A
16	7/8"-20 UNEF 2A
16S	7/8"-20 UNEF 2A
18	1"-20 UNEF 2A
20	1-1/8"-18 UNEF 2A
22	1-1/4"-18 UNEF 2A
24	1-3/8"-18 UNEF 2A
28	1-5/8"-18 UNEF 2A
32	1-7/8"-16 UN 2A
36	2-1/16"-16 UN 2A
40	2-5/16"-16 UN 2A

Front Panel Mounting Receptacle

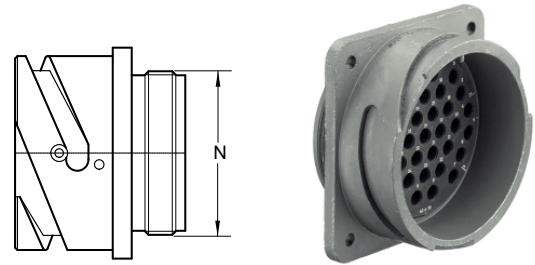

Detailed technical specifications: <http://www.moltecinternational.com/datasheets/receptacles.pdf>



ACCORDING TO
MIL-DTL-5015/VG-95234
CIRCULAR CONNECTORS

- Aluminum Receptacle
- Contact layouts available up to 85 contacts
- Cable cross-sections of 0.5 up to 50 mm²
- High mechanical loading capacity
- Resistant against fuels & insulating oils
- Lifespan of minimum 500 mating cycles
- Elastic insert for pressed in crimp contacts

Size	N Thread (Inches)
10SL	5/8"-24 UNEF 2A
14S	3/4"-20 UNEF 2A
16	7/8"-20 UNEF 2A
16S	7/8"-20 UNEF 2A
18	1"-20 UNEF 2A
20	1-1/8"-18 UNEF 2A
22	1-1/4"-18 UNEF 2A
24	1-3/8"-18 UNEF 2A
28	1-5/8"-18 UNEF 2A
32	1-7/8"-16 UN 2A
36	2-1/16"-16 UN 2A
40	2-5/16"-16 UN 2A

Rear Panel Mounting Receptacle

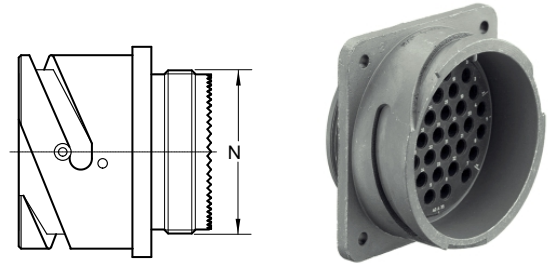

Detailed technical specifications: <http://www.moltecinternational.com/datasheets/receptacles.pdf>



ACCORDING TO
MIL-DTL-5015/VG-95234
CIRCULAR CONNECTORS

- Aluminum Receptacle
- Contact layouts available up to 85 contacts
- Cable cross-sections of 0.5 up to 50 mm²
- High mechanical loading capacity
- Resistant against fuels & insulating oils
- Lifespan of minimum 500 mating cycles
- Elastic insert for pressed in crimp contacts

Size	N Thread (Inches)
10SL	5/8"-24 UNEF 2A
14S	3/4"-20 UNEF 2A
16	7/8"-20 UNEF 2A
16S	7/8"-20 UNEF 2A
18	1"-20 UNEF 2A
20	1-1/8"-18 UNEF 2A
22	1-1/4"-18 UNEF 2A
24	1-3/8"-18 UNEF 2A
28	1-5/8"-18 UNEF 2A
32	1-7/8"-16 UN 2A
36	2-1/16"-16 UN 2A
40	2-5/16"-16 UN 2A

Jam Nut Receptacle

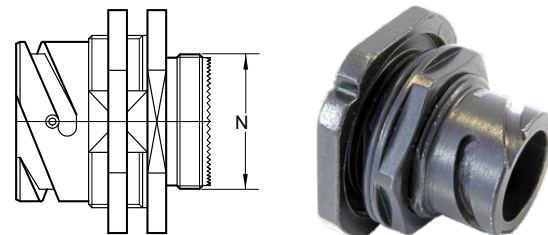

Detailed technical specifications: <http://www.moltecinternational.com/datasheets/receptacles.pdf>



ACCORDING TO
MIL-DTL-5015/VG-95234
CIRCULAR CONNECTORS

- Aluminum Receptacle
- Contact layouts available up to 85 contacts
- Cable cross-sections of 0.5 up to 50 mm²
- High mechanical loading capacity
- Resistant against fuels & insulating oils
- Lifespan of minimum 500 mating cycles
- Elastic insert for pressed in crimp contacts

Size	N Thread (Inches)
10SL	5/8"-24 UNEF 2A
14S	3/4"-20 UNEF 2A
16	7/8"-20 UNEF 2A
16S	7/8"-20 UNEF 2A
18	1"-20 UNEF 2A
20	1-1/8"-18 UNEF 2A
22	1-1/4"-18 UNEF 2A
24	1-3/8"-18 UNEF 2A
28	1-5/8"-18 UNEF 2A
32	1-7/8"-16 UN 2A
36	2-1/16"-16 UN 2A
40	2-5/16"-16 UN 2A

Inline Receptacle

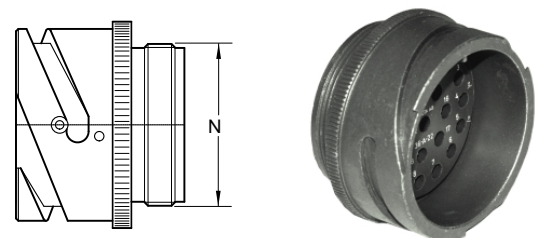

Detailed technical specifications: <http://www.moltecinternational.com/datasheets/receptacles.pdf>

TRAC D-Sub connectors were developed for use in supervisory control systems within the rail industry. TRAC connectors are fitted with sturdy cast-zinc covers for 360° EMI screening and can be coded if required. The connectors comply with protection class IP44 as per EN 60529, and are approved for indoor applications.

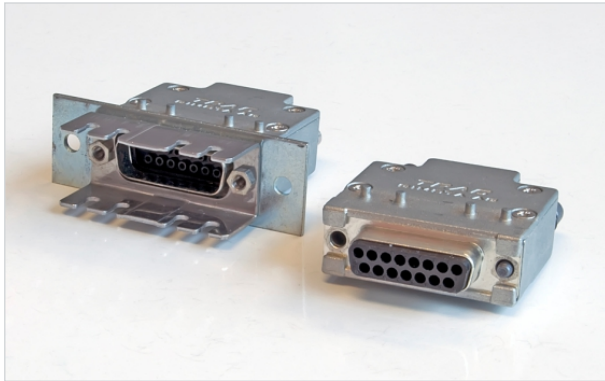

- Solid zinc cast housing
- Strain relief separately on each cable
- Cable connection between screen and screen clamp sleeve
- Excellent contact between the housing and the cable clamp (also at higher currents)
- Simply codable (also after assembling)
- All accessories screws of stainless steel
- RoHS-Compliant

SUB-D connectors from the TRAC series can be ordered either as single parts or as sets.

Electrical Properties		D-SUB TRAC	D-SUB TRAC H
Socket housing		Type SUH...S	Type SUHV...S
Pin housing		Type SUH...P	Type SUHV...P
Test voltage	[V] AC 1 Min	1000	1500
Service voltage	[V] AC/DC	125	125
Operation current at 20°C	[A]	Max. 3	Max. 3
Potential drop across contacts	[mV]	Max. 24	Max. 24
Creepage distance in connecting zone	[mm]	Min. 1.5	Min. 3
Creep resistance acc. To IEC 60664	CTI-Wert	>300	>300
Insulation resistance	[MW]	>5000	>5000

Thermal properties / Fire characteristics		D-SUB TRAC / TRAC H
Contact housing material		Thermoplastic, black
Service temperature		-55°C to +105°C
Fire resistance class	UL 94	V-0

Mechanical properties contacts		D-SUB TRAC / TRAC H
		According to DIN IEC 60512-5
Connecting life cycle of contacts	Mating cycles	Min. 500
Separating force of contacts	[N]	>0.2
Mating force of contact	[N]	<3.4
Terminal cross section: Data signal contacts		0.2 to 0.56mm ² AWG24-20
Terminal cross section: Power contacts		0.8 to 8mm ² AWG18-8

Mechanical properties connectors		D-SUB TRAC / TRAC H
Cover		3 sizes, screw-on cover
Cover material		Zinc cast (self-passivating)
Contact housing material		Thermoplastic, black
Screw material		Stainless steel V2A
EMI shielding		With compressible shielding sleeve: 360°
Coding		at least 24 possibilities (mechanically)
Cable strain relief		crimpable or with cable tie up to 150 N

Detailed technical specifications: <http://www.moltecininternational.com/datasheets/trac.pdf>

The new GTM12 connector series allows assembling in the field. Easy installation and crimping of contacts with the appropriate crimping tools is ensured at the workshop. The connectors provide a very compact design and allow a robust and seal-tight connection of electronic equipment.



Cable plug M12 D coded (GTM12-D-MP-xx)

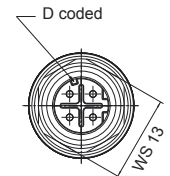
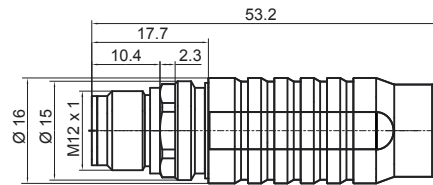

Bayonet cable plug M12B D coded (GTM12B-D-MP-xx)

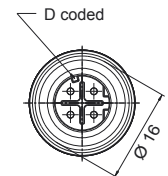
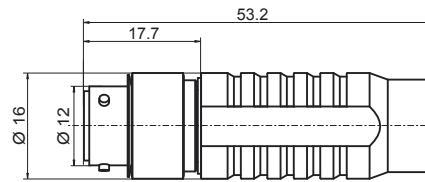

Cable receptacle M12 D coded (GTM12-D-FS-xx)

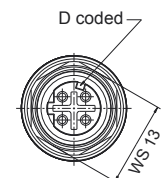
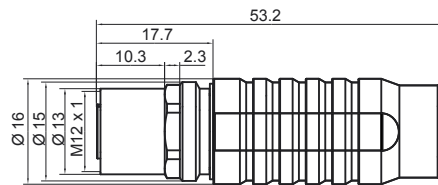

Rear panel bulkhead cable receptacle M12 D coded (GTM12-D-BR-FS-xx)

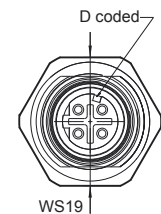
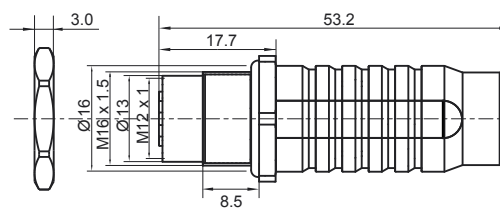

Detailed technical specifications: <http://www.moltecinternational.com/datasheets/gtm12.pdf>

Tin-plated copper braid is safely used against magnetic fields. It is suitable for grounding of electrical cabinets, automotive and railways. It is also used as an extra-flexible conductor and connected to the fittings, guarantees continuity and meets the requirements of shield protection, including power, grounding and equipotential connection. Covering rate of the braid greater than 95%.

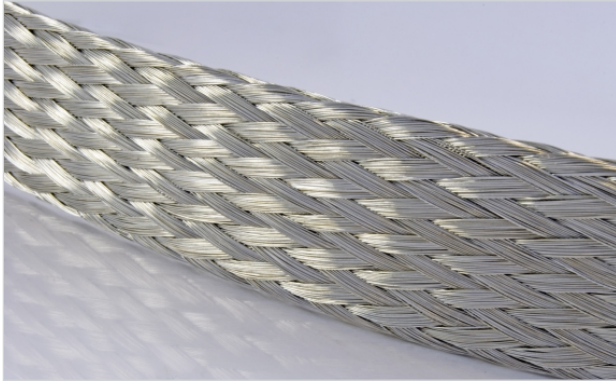

- Made in compliance with AA59569
- Raw material meets ASTM B33 requirement

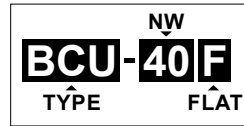

Specifications are subject to change without notice

BCUF

Order No.	Fits to Conduit	Nominal Flat Width		Nominal Dimension Opens up to		AWG of Individual Ends	No. of Carriers	No. Ends Per Carrier	Aproximate Circular Mill Area	Approx. Shipping Weight
		mm	in	mm	in					Lbs/1000 Ft
BCU-10F	NW10 - NW12	6.5	0.26	14.0	0.55	36	24	14	4,200	17
BCU-15F	NW17 - NW23	13.5	0.53	24.1	0.95	36	48	15	14,400	48
BCU-20F	NW23 - NW29	16.0	0.63	35.0	1.90	34	48	10	19,080	62
BCU-40F	NW36 - NW48	20.5	0.81	48.3	1.90	34	48	22	41,976	140

B04 F Stainless Steel Braid

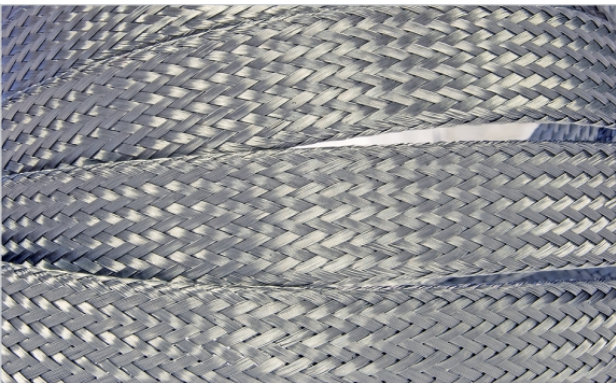

- Virtually indestructible 304 stainless steel
- Will not discolor or rust
- Resists abrasion, chemicals & UV
- Easy to install
- Cuts with shears or serrated scissors
- Halogen free

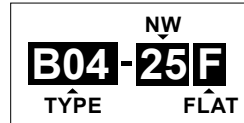

Specifications are subject to change without notice

B04F

Order No.	Nominal I.D.		Expansion Range Min. - Max.				Wall Thickness		PU		AWG of Ends	Carriers	Wires/Carrier	Total Ends	Weight Lbs/100'
	mm	in	mm	in	mm	in	mm	in	M	F					
B04-07F	6.4	1/4"	4.8	0.19	10.3	0.41	0.33	0.013	30	100	36	24	13	312	2.20
B04-10F	9.5	3/8"	6.4	0.25	15.9	0.63	0.33	0.013	30	100	36	48	7	336	2.54
B04-13F	12.7	1/2"	9.5	0.37	19.1	0.75	0.33	0.013	15	50	36	48	11	528	3.15
B04-20F	19.1	3/4"	12.7	0.50	31.8	1.25	0.33	0.013	15	50	36	48	15	720	6.90
B04-25F	25.4	1"	15.9	0.63	33.3	1.31	0.33	0.013	15	50	30	48	7	336	9.78
B04-32F	31.8	1-1/4"	19.1	0.75	44.5	1.75	0.33	0.013	15	50	30	48	10	480	13.70
B04-40F	38.1	1-1/2"	25.4	1.00	54.0	2.13	0.33	0.013	15	50	30	48	12	576	16.60

- Wire Size Range: 8AWG to 250 MCM
- MATERIAL:
 - Terminal Body: Copper per ASTM B-152
 - Plating: Tin per ASTM B-545
- High conductivity ETP copper
- Utilize seamless drawn body
- Flared wire barrel
- Copper and tin plating available
- Sight hole versions available for wire inspection
- Multiple tongue widths available
- Bent tongues available at angles up to 90°

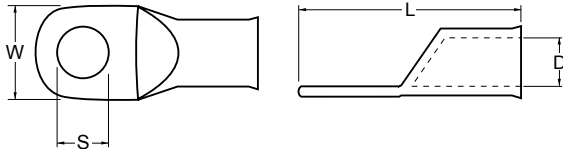

STANDARD RING	COLOUR CODED (Y or N)	STUD HOLE SIZE	FLARED COLLAR
SLR	R	8N	-445/516NF
SEAMLESS TERMINAL LUG	AWG SIZE	TONGUE WIDTH	INSPECTION HOLE (Y or N)

Specifications are subject to change without notice

Part Number	Wire Size	Stud Size		Dimensions					
		S		D		L		W	
		(in)	M	(mm)	(in)	(mm)	(in)	(mm)	(in)
SLR-8N-445/190NF	8	10	5	4.70	0.18	30.48	1.20	11.30	0.45
SLR-8N-445/14NF	8	1/4	6	4.70	0.18	30.48	1.20	11.30	0.45
SLR-8N-445/516NF	8	5/16	8	4.70	0.18	30.48	1.20	11.30	0.45
SLR-8N-605/14NF	8	1/4	6	4.70	0.18	33.15	1.31	15.37	0.61
SLR-8N-605/516NF	8	5/16	8	4.70	0.18	33.15	1.31	15.37	0.61
SLR-8N-605/38NF	8	3/8	10	4.70	0.18	33.15	1.31	15.37	0.61
SLR-8N-765/38NF	8	3/8	10	4.70	0.18	37.59	1.48	19.45	0.77
SLR-8N-765/12NF	8	1/2	12	4.70	0.18	37.59	1.48	19.45	0.77
SLR-6N-445/190NF	6	10	5	5.89	0.23	32.26	1.27	11.30	0.45
SLR-6N-445/14NF	6	1/4	6	5.89	0.23	32.26	1.27	11.30	0.45
SLR-6N-445/516NF	6	5/16	8	5.89	0.23	32.26	1.27	11.30	0.45
SLR-6N-605/14NF	6	1/4	6	5.89	0.23	35.81	1.41	15.37	0.61
SLR-6N-605/516NF	6	5/16	8	5.89	0.23	35.81	1.41	15.37	0.61
SLR-6N-605/38NF	6	3/8	10	5.89	0.23	35.81	1.41	15.37	0.61
SLR-6N-765/38NF	6	3/8	10	5.89	0.23	39.37	1.55	19.45	0.77
SLR-6N-765/12NF	6	1/2	12	5.89	0.23	39.37	1.55	19.45	0.77
SLR-4N-525/190NF	4	10	5	7.26	0.29	38.10	1.50	13.33	0.53
SLR-4N-525/14NF	4	1/4	6	7.26	0.29	38.10	1.50	13.33	0.53
SLR-4N-525/516NF	4	5/16	8	7.26	0.29	38.10	1.50	13.33	0.53
SLR-4N-525/38NF	4	3/8	10	7.26	0.29	38.10	1.50	13.33	0.53
SLR-4N-625/516NF	4	5/16	8	7.26	0.29	38.89	1.53	15.88	0.63
SLR-4N-625/38NF	4	3/8	10	7.26	0.29	38.89	1.53	15.88	0.63
SLR-4N-765/38NF	4	3/8	10	7.26	0.29	42.85	1.68	19.45	0.77
SLR-4N-765/12NF	4	1/2	12	7.26	0.29	42.85	1.68	19.45	0.77
SLR-2N-615/14NF	2	1/4	6	8.53	0.34	41.27	1.62	15.62	0.62
SLR-2N-615/516NF	2	5/16	8	8.53	0.34	41.27	1.62	15.62	0.62
SLR-2N-615/38NF	2	3/8	10	8.53	0.34	41.27	1.62	15.62	0.62
SLR-2N-755/38NF	2	3/8	10	8.53	0.34	44.45	1.75	19.18	0.76
SLR-2N-755/12NF	2	1/2	12	8.53	0.34	44.45	1.75	19.18	0.76
SLR-1N-655/14NF	1	1/4	6	9.14	0.36	43.69	1.72	16.64	0.66

Part Number	Wire Size	Stud Size		Dimensions					
		S		D		L		W	
		(in)	M	(mm)	(in)	(mm)	(in)	(mm)	(in)
SLR-1N-655/38NF	1	3/8	10	9.14	0.36	43.69	1.72	16.64	0.66
SLR-1N-655/12NF	1	1/2	12	9.14	0.36	43.69	1.72	16.64	0.66
SLR-1N-755/38NF	1	3/8	10	9.14	0.36	46.48	1.83	19.18	0.76
SLR-1N-755/12NF	1	1/2	12	9.14	0.36	46.48	1.83	19.18	0.76
SLR-1/0N-725/14NF	1/0	1/4	6	10.33	0.41	46.48	1.83	18.41	0.73
SLR-1/0N-725/516NF	1/0	5/16	8	10.33	0.41	46.48	1.83	18.41	0.73
SLR-1/0N-725/38NF	1/0	3/8	10	10.33	0.41	46.48	1.83	18.41	0.73
SLR-1/0N-725/12NF	1/0	1/2	12	10.33	0.41	46.48	1.83	18.41	0.73
SLR-1/0N-825/38NF	1/0	3/8	10	10.33	0.41	48.26	1.90	20.96	0.83
SLR-1/0N-825/12NF	1/0	1/2	12	10.33	0.41	48.26	1.90	20.96	0.83
SLR-2/0N-815/14NF	2/0	1/4	6	11.71	0.46	52.37	2.06	20.70	0.82
SLR-2/0N-815/516NF	2/0	5/16	8	11.71	0.46	52.37	2.06	20.70	0.82
SLR-2/0N-815/38NF	2/0	3/8	10	11.71	0.46	52.37	2.06	20.70	0.82
SLR-2/0N-815/12NF	2/0	1/2	12	11.71	0.46	52.37	2.06	20.70	0.82
SLR-3/0N-895/14NF	3/0	1/4	6	12.98	0.51	54.86	2.16	22.73	0.90
SLR-3/0N-895/516NF	3/0	5/16	8	12.98	0.51	54.86	2.16	22.73	0.90
SLR-3/0N-895/38NF	3/0	3/8	10	12.98	0.51	54.86	2.16	22.73	0.90
SLR-3/0N-895/12NF	3/0	1/2	12	12.98	0.51	54.86	2.16	22.73	0.90
SLR-4/0N-985/14NF	4/0	1/4	6	14.20	0.56	59.69	2.35	25.02	0.99
SLR-4/0N-985/516NF	4/0	5/16	8	14.20	0.56	59.69	2.35	25.02	0.99
SLR-4/0N-985/38NF	4/0	3/8	10	14.20	0.56	59.69	2.35	25.02	0.99
SLR-4/0N-985/12NF	4/0	1/2	12	14.20	0.56	59.69	2.35	25.02	0.99
SLR-4/0N-1035/38NF	4/0	3/8	10	14.99	0.59	60.71	2.39	26.29	1.04
SLR-4/0N-1035/12NF	4/0	1/2	12	14.99	0.59	60.71	2.39	26.29	1.04
SLR-4/0N-1035/58NF	4/0	5/8	16	14.99	0.59	60.71	2.39	26.29	1.04
SLR-4/0N-1090/38NF	4/0	3/8	10	15.87	0.63	62.68	2.46	27.76	1.09
SLR-4/0N-1090/12NF	4/0	1/2	12	15.87	0.63	62.68	2.46	27.76	1.09
SLR-4/0N-1090/58NF	4/0	5/8	16	15.87	0.63	62.68	2.46	27.76	1.09
SLR-250N-1200/38NF	250 MCM	3/8	10	17.40	0.69	67.46	2.65	30.55	1.20
SLR-250N-1200/12NF	250 MCM	1/2	12	17.40	0.69	67.46	2.65	30.55	1.20
SLR-250N-1200/58NF	250 MCM	5/8	16	17.40	0.69	67.46	2.65	30.55	1.20

For more terminals & splices information <http://www.moltecinternational.com/catalogues/terminals/index.html>





- Highly flexible braid with seamless & solderless pressed contact areas.
- **Material:** ETP Copper.
- **Surface area finish:** Tin plated standard, uncoated, nickel plated, silver plated, or others on request.
- **Insulation:** Uninsulated standard, PVC-tubing, silicone, Heatshrink, fiberglass, or others on request.
- Contact areas rectangular with bending protection, It is also possible to change the length of all contact areas.
- Standard design without drilling. On request drilling according to **Type 1, 2, 4**, or customers' wishes are available.
- **Custom designs:** We also manufacture in coordination with your applications & according to your drawings or samples.

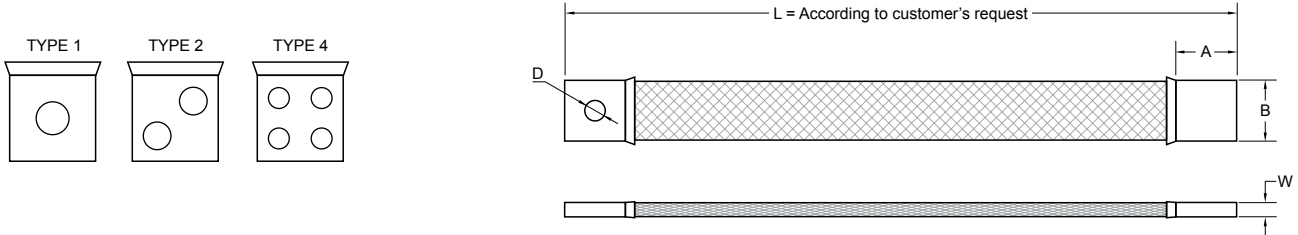

<p>TYPE</p> <p>GSF-BA</p> <p>SURFACE FINISH</p>	<p>INSULATION</p> <p>A</p> <p>SERIES</p>	<p>LENGTH</p> <p>945-0.47m</p> <p>METERS</p>	<p>SURFACE FINISH</p> <p>A UNCOATED</p> <p>B TIN PLATED</p> <p>C NICKEL PLATED</p> <p>D SILVER PLATED</p>	<p>INSULATION</p> <p>A UNINSULATED</p> <p>B NYLON CONDUIT</p> <p>C SILICONE TUBING</p> <p>D HEATSHRINK</p> <p>E FIBERGLASS</p>
--	---	---	--	--

Order No.	Cross section	Type	A		B		W		D	
	mm ²		holes	mm	in	mm	in	mm	in	mm
GSF-BA930	25	1	20.0	0.79	20.0	0.79	3.5	0.14	11.0	0.43
GSF-BA931	50	1	20.0	0.79	20.0	0.79	5.0	0.20	11.0	0.43
GSF-BA932	75	1	20.0	0.79	20.0	0.79	7.0	0.28	11.0	0.43
GSF-BA933	100	1	20.0	0.79	20.0	0.79	9.0	0.35	11.0	0.43
GSF-BA934	25	1	25.0	0.98	25.0	0.98	3.5	0.14	11.0	0.43
GSF-BA935	50	1	25.0	0.98	25.0	0.98	4.5	0.18	11.0	0.43
GSF-BA936	75	1	25.0	0.98	25.0	0.98	6.0	0.24	11.0	0.43
GSF-BA937	100	1	25.0	0.98	25.0	0.98	7.0	0.28	11.0	0.43
GSF-BA938	125	1	25.0	0.98	25.0	0.98	8.5	0.33	11.0	0.43
GSF-BA939	50	1	30.0	1.18	30.0	1.18	4.0	0.16	11.0	0.43
GSF-BA940	75	1	30.0	1.18	30.0	1.18	5.0	0.20	11.0	0.43
GSF-BA941	100	1	30.0	1.18	30.0	1.18	6.0	0.24	11.0	0.43
GSF-BA942	150	1	30.0	1.18	30.0	1.18	8.5	0.33	11.0	0.43
GSF-BA943	200	1	30.0	1.18	30.0	1.18	11.5	0.45	11.0	0.43
GSF-BA944	300	1	30.0	1.18	30.0	1.18	15.5	0.61	14.0	0.55
GSF-BA945	100	1	40.0	1.57	40.0	1.57	7.5	0.30	14.0	0.55
GSF-BA946	150	1	40.0	1.57	40.0	1.57	7.5	0.30	14.0	0.55
GSF-BA947	200	1	40.0	1.57	40.0	1.57	9.5	0.37	14.0	0.55
GSF-BA948	250	1	40.0	1.57	40.0	1.57	10.5	0.41	14.0	0.55
GSF-BA949	300	1	40.0	1.57	40.0	1.57	13.0	0.51	14.0	0.55
GSF-BA950	400	1	40.0	1.57	40.0	1.57	15.5	0.61	14.0	0.55
GSF-BA951	140	2	50.0	1.97	50.0	1.97	6.0	0.24	14.0	0.55
GSF-BA952	210	2	50.0	1.97	50.0	1.97	8.2	0.32	14.0	0.55
GSF-BA953	280	2	50.0	1.97	50.0	1.97	10.0	0.39	14.0	0.55

Order No.	Cross section	Type	A		B		W		D	
	mm ²		holes	mm	in	mm	in	mm	in	mm
GSF-BA954	420	2	50.0	1.97	50.0	1.97	14.0	0.55	14.0	0.55
GSF-BA955	560	2	50.0	1.97	50.0	1.97	16.2	0.64	14.0	0.55
GSF-BA956	140	2	60.0	2.36	60.0	2.36	6.5	0.26	14.0	0.55
GSF-BA957	210	2	60.0	2.36	60.0	2.36	8.0	0.31	14.0	0.55
GSF-BA958	350	2	60.0	2.36	60.0	2.36	11.2	0.44	14.0	0.55
GSF-BA959	490	2	60.0	2.36	60.0	2.36	13.1	0.52	14.0	0.55
GSF-BA960	560	2	60.0	2.36	60.0	2.36	15.0	0.59	14.0	0.55
GSF-BA961	340	4	80.0	3.15	80.0	3.15	9.5	0.37	14.0	0.55
GSF-BA962	520	4	80.0	3.15	80.0	3.15	11.5	0.45	14.0	0.55
GSF-BA963	700	4	80.0	3.15	80.0	3.15	14.5	0.57	14.0	0.55
GSF-BA964	840	4	80.0	3.15	80.0	3.15	16.0	0.63	14.0	0.55
GSF-BA965	1000	4	80.0	3.15	80.0	3.15	19.3	0.76	14.0	0.55
GSF-BA966	500	4	100.0	3.94	100.0	3.94	11.0	0.43	14.0	0.55
GSF-BA967	670	4	100.0	3.94	100.0	3.94	12.3	0.48	14.0	0.55
GSF-BA968	860	4	100.0	3.94	100.0	3.94	14.5	0.57	14.0	0.55
GSF-BA969	1000	4	100.0	3.94	100.0	3.94	17.5	0.69	14.0	0.55
GSF-BA970	1200	4	100.0	3.94	100.0	3.94	19.0	0.75	14.0	0.55
GSF-BA971	1500	4	100.0	3.94	100.0	3.94	23.5	0.93	14.0	0.55
GSF-BA972	610	4	120.0	4.72	120.0	4.72	11.7	0.46	14.0	0.55
GSF-BA973	1000	4	120.0	4.72	120.0	4.72	16.0	0.63	14.0	0.55
GSF-BA974	1540	4	120.0	4.72	120.0	4.72	21.2	0.83	14.0	0.55
GSF-BA975	2000	4	120.0	4.72	120.0	4.72	26.2	1.03	14.0	0.55
GSF-BA976	3000	4	120.0	4.72	120.0	4.72	36.2	1.43	14.0	0.55
GSF-BA977	4500	4	120.0	4.72	120.0	4.72	51.0	2.01	14.0	0.55

- Highly flexible rounded cables braid with seamless & solder-less pressed contact areas.
- **Material:** ETP Copper.
- **Surface area finish:** Tin plated standard, uncoated, nickel plated, silver plated, or others on request
- **Insulation:** Uninsulated standard, PVC-tubing, silicone, Heatshrink, fiberglass, or others on request.
- Contact areas rectangular with bending protection, It is also possible to change the length of all contact areas.
- Standard drilling according to **Type 1** or **2**, Available also customer's request.
- **Custom designs:** We also manufacture in coordination with your applications & according to your drawings or samples.

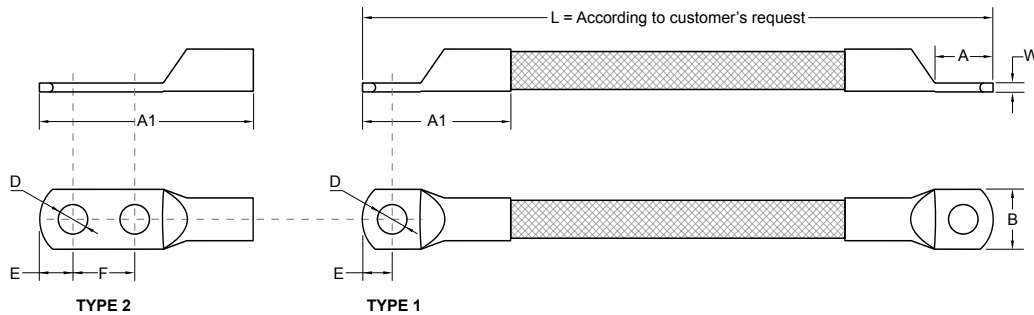

TYPE	INSULATION	LENGTH	SURFACE FINISH				INSULATION				
GSR-BB	665	0.47m	A	UNCOATED	A	UNINSULATED					
	B		B	TIN PLATED	B	NYLON CONDUIT					
			C	NICKEL PLATED	C	SILICONE TUBING					
			D	SILVER PLATED	D	HEATSHRINK					
					E	FIBERGLASS					

Order No.	Cross section	Type	A		A1		B		D		E		F		W	
	mm ²		holes	mm	in	mm	in	mm	in	mm	in	mm	in	mm	in	mm
GSR-BA660	70	1	15.0	0.59	35.0	1.38	15.0	0.59	7.0	0.28	7.5	0.30	-	-	8.5	0.33
GSR-BA661	95	1	20.0	0.79	50.0	1.97	20.0	0.79	9.0	0.35	10.0	0.39	-	-	8.2	0.32
GSR-BA662	120	1	20.0	0.79	50.0	1.97	20.0	0.79	9.0	0.35	10.0	0.39	-	-	11.0	0.43
GSR-BA663	150	1	25.0	0.98	55.0	2.17	25.0	0.98	11.0	0.43	12.5	0.49	-	-	11.5	0.45
GSR-BA664	185	1	25.0	0.98	55.0	2.17	25.0	0.98	11.0	0.43	12.5	0.49	-	-	13.0	0.51
GSR-BA665	240	1	32.0	1.26	62.0	2.44	32.0	1.26	11.0	0.43	16.0	0.63	-	-	12.5	0.49
GSR-BA666	300	1	40.0	1.57	95.0	3.74	40.0	1.57	14.0	0.55	20.0	0.79	-	-	13.5	0.53
GSR-BA667	400	1	40.0	1.57	95.0	3.74	40.0	1.57	14.0	0.55	20.0	0.79	-	-	15.5	0.61
GSR-BA668	500	1	40.0	1.57	95.0	3.74	40.0	1.57	14.0	0.55	20.0	0.79	-	-	22.0	0.87
GSR-BA669	600	1	40.0	1.57	95.0	3.74	55.0	2.17	14.0	0.55	20.0	0.79	-	-	17.0	0.67
GSR-BA670	750	1	40.0	1.57	95.0	3.74	55.0	2.17	14.0	0.55	20.0	0.79	-	-	21.0	0.83
GSR-BA671	850	1	40.0	1.57	95.0	3.74	55.0	2.17	14.0	0.55	20.0	0.79	-	-	22.3	0.88
GSR-BA672	1000	1	50.0	1.97	105.0	4.13	60.0	2.36	14.0	0.55	20.0	0.79	-	-	24.5	0.96
GSR-BA645	70	2	30.0	1.18	50.0	1.97	15.0	0.59	7.0	0.28	7.5	0.30	15.0	0.59	8.5	0.33
GSR-BA646	95	2	40.0	1.57	70.0	2.76	20.0	0.79	9.0	0.35	10.0	0.39	20.0	0.79	8.2	0.32
GSR-BA647	120	2	40.0	1.57	70.0	2.76	20.0	0.79	9.0	0.35	10.0	0.39	20.0	0.79	11.0	0.43
GSR-BA648	150	2	50.0	1.97	80.0	3.15	25.0	0.98	11.0	0.43	12.5	0.49	25.0	0.98	11.5	0.45
GSR-BA649	185	2	50.0	1.97	80.0	3.15	25.0	0.98	11.0	0.43	12.5	0.49	25.0	0.98	13.0	0.51
GSR-BA650	240	2	60.0	2.36	90.0	3.54	32.0	1.26	11.0	0.43	16.0	0.63	32.0	1.26	12.5	0.49
GSR-BA651	300	2	80.0	3.15	135.0	5.31	40.0	1.57	14.0	0.55	20.0	0.79	40.0	1.57	13.5	0.53
GSR-BA652	400	2	80.0	3.15	135.0	5.31	40.0	1.57	14.0	0.55	20.0	0.79	40.0	1.57	15.5	0.61
GSR-BA653	500	2	80.0	3.15	135.0	5.31	40.0	1.57	14.0	0.55	20.0	0.79	40.0	1.57	22.0	0.87
GSR-BA654	600	2	80.0	3.15	135.0	5.31	55.0	2.17	14.0	0.55	20.0	0.79	40.0	1.57	17.0	0.67
GSR-BA655	750	2	80.0	3.15	135.0	5.31	55.0	2.17	14.0	0.55	20.0	0.79	40.0	1.57	21.0	0.83
GSR-BA656	850	2	80.0	3.15	135.0	5.31	55.0	2.17	14.0	0.55	20.0	0.79	40.0	1.57	22.3	0.88
GSR-BA657	1000	2	80.0	3.15	135.0	5.31	60.0	2.36	14.0	0.55	20.0	0.79	40.0	1.57	24.5	0.96

TEAFLEX



- Locking device system provides a quick and secure push-in connection of corrugated conduits
- High-grade formulated polyamide
- Self-extinguishing, free from halogens and cadmium
- Excellent impact strength
- Temperature range: -40°C(-40°F) to 105°C(221°F)
- Short-term to 160°C(320°F)
- Up to IP68 / NEMA 6P protection with the reinforced sealing cap at conduit side
- Colour: Black standard, other colours available upon request

IP RATING	SHAPE	NW2
K8-S-T-101010		
COLOUR MATERIAL	SÉRIES TYPE	NW1 NW3

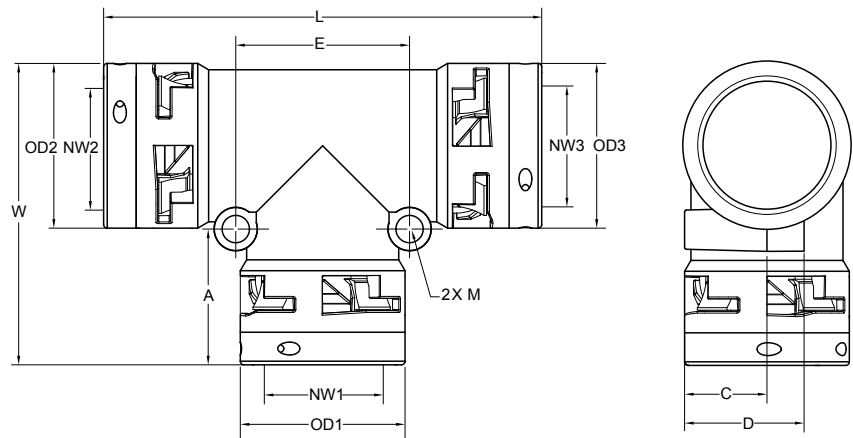

Specifications are subject to change without notice

Order No.	Order No.	Fits to Conduit NW1-NW2-NW3	A		C		D		E		W		L		M	OD1 / OD2 / OD3	
			mm	in	mm	in	mm	in	mm	in	mm	in	mm	in		mm	in
			24.5	0.96	10.0	0.39	16	0.63	21.0	0.83	44.9	1.77	69.8	2.75	4	20.0	0.79
Ⓢ K6-S-T-121212	K8-S-T-121212	12 - 12 - 12	27.0	1.06	12.0	0.47	18	0.71	26.0	1.02	51.7	2.03	79.3	3.12	4	24.0	0.94
Ⓢ K6-S-T-171717	K8-S-T-171717	17 - 17 - 17	28.0	1.10	15.0	0.59	22	0.87	32.0	1.26	58.4	2.30	86.7	3.41	5	30.0	1.18
Ⓢ K6-S-T-232323	K8-S-T-232323	23 - 23 - 23	36.0	1.42	19.0	0.75	26	1.02	40.0	1.57	75.0	3.97	112.0	4.41	6	38.0	1.50
Ⓢ K6-S-T-292929	K8-S-T-292929	29 - 29 - 29	37.5	1.48	22.8	0.90	33	1.30	48.0	1.89	83.3	3.28	121.0	4.76	6	45.5	1.79
Ⓢ K6-S-T-363636	K8-S-T-363636	36 - 36 - 36	44.5	1.75	28.5	1.12	38	1.50	58.0	2.28	100.8	3.97	144.5	5.69	6	57.0	2.24
Ⓢ K6-S-T-484848	K8-S-T-484848	48 - 48 - 48	52.0	2.05	34.0	1.34	47	1.85	70.0	2.76	118.8	4.68	169.5	6.67	6	68.0	2.68

KDT T Divisible Splice Connector

To be used with slit conduit type PLF & NLF (Page 23)



- One-piece, snap-on connector with/without flexible hinge for 90-degree T-branches
- Perfect protection and routing of cables at 90-degree branch angles, quick to assemble
- High-grade formulated polyamide
- **UL 94 HB/V-2 FMVSS**, Self-extinguishing, free from halogens and cadmium
- Robust, one-piece, high mechanical strength, no pressure required to secure the connector
- Temperature range: -40°C(-40°F) to 105°C(221°F), Short-term to 160°C(320°F)
- Colour: Black standard, other colours available upon request

Detailed Technical specifications: <http://www.moltecinternational.com/datasheets/kdt.pdf>



- Locking device system provides a quick and secure push-in connection of corrugated conduits
- High-grade formulated polyamide
- Self-extinguishing, free from halogens and cadmium
- Excellent impact strength
- Temperature range: -40°C(-40°F) to 105°C(221°F)
- Short-term to 160°C(320°F)
- Up to IP68 / NEMA 6P protection with the reinforced sealing cap at conduit side
- Colour: Black standard, other colours available upon request

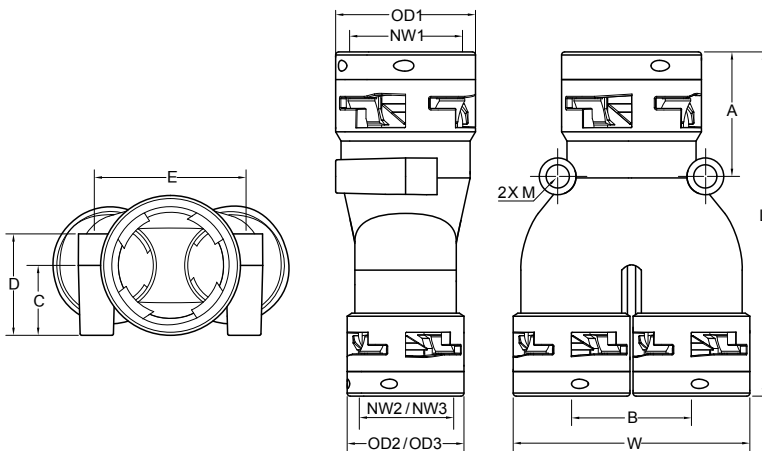

IP RATING	SHAPE	NW2
K8-S-Y-121010		
COLOUR MATERIAL	SÉRIES TYPE	NW1 NW3

Specifications are subject to change without notice

Order No.	Order No.	Fits to Conduit	A		B		C		D		E		W		L		M	OD1		OD2 / OD3	
			mm	in	mm	in	mm	in	mm	in	mm	in	mm	in	mm	in		mm	in	mm	in
K6-S-Y-100707	K8-S-Y-100707	10 - 7 - 7	26.0	1.02	18.0	0.71	10.0	0.39	16.0	0.63	21.0	0.83	35.0	1.38	69.4	2.73	4	20.0	0.79	17.0	0.67
K6-S-Y-121010	K8-S-Y-121010	12 - 10 - 10	29.0	1.14	21.0	0.83	12.0	0.47	18.0	0.71	26.0	1.02	41.0	1.61	74.0	2.91	4	24.0	0.94	20.0	0.79
K6-S-Y-171212	K8-S-Y-171212	17 - 12 - 12	32.0	1.26	25.0	0.98	15.0	0.59	22.0	0.87	32.0	1.26	49.0	1.93	82.5	3.25	5	30.0	1.18	24.0	0.94
K6-S-Y-231717	K8-S-Y-231717	23 - 17 - 17	40.0	1.57	31.0	1.22	19.0	0.75	26.0	1.02	40.0	1.57	61.0	2.40	96.0	3.78	6	38.0	1.50	30.0	1.18
K6-S-Y-292323	K8-S-Y-292323	29 - 23 - 23	40.5	1.59	39.0	1.54	22.8	0.90	33.0	1.30	48.0	1.89	77.0	3.03	112.0	4.41	6	45.5	1.79	38.0	1.50
K6-S-Y-362929	K8-S-Y-362929	36 - 29 - 29	50.0	1.97	46.5	1.83	28.5	1.12	38.0	1.50	58.0	2.28	92.0	3.62	130.0	5.12	6	57.0	2.24	45.5	1.79
K6-S-Y-483636	K8-S-Y-483636	48 - 36 - 36	55.0	2.17	58.0	2.28	34.0	1.34	47.0	1.85	70.0	2.76	115.0	4.53	148.5	5.85	6	68.0	2.68	57.0	2.24

KDY Y Divisible Splice Connector

To be used with slit conduit type PLF & NLF (Page 23)

- One-piece, snap-on connector with/without flexible hinge for 45-degree Y-branches
- Perfect protection and routing of cables at 45-degree branch angles, quick to assemble
- High-grade formulated polyamide
- UL 94 HB/V-2 FMVSS, Self-extinguishing, free from halogens and cadmium
- Robust, one-piece, high mechanical strength, no pressure required to secure the connector
- Temperature range: -40°C(-40°F) to 105°C(221°F), Short-term to 160°C(320°F)
- Colour: Black standard, other colours available upon request



Detailed Technical specifications: <http://www.moltecinternational.com/datasheets/kdy.pdf>

TEARFLX



- Locking device system provides a quick and secure push-in connection of corrugated conduits
- High-grade formulated polyamide
- Self-extinguishing, free from halogens and cadmium
- Temperature range: -40°C(-40°F) to 105°C(221°F)
- Short-term to 160°C(320°F)
- Up to IP68 / NEMA 6P protection with the reinforced sealing cap at conduit side

IP RATING	SHAPE	NW
K8-S-S-1717		
COLOUR MATERIAL	SÉRIES TYPE	NW

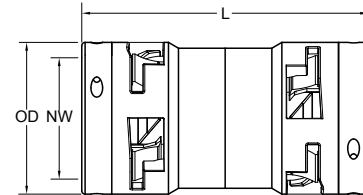

Specifications are subject to change without notice

	Order No.	Order No.	Fits to Conduit			L		OD	
	IP66	IP68	NW	mm	in	mm	in	mm	in
	K6-S-S-1717	K8-S-S-1717	17	20	1/2	65.7	2.59	30.0	1.18
	K6-S-S-2323	K8-S-S-2323	23	25	3/4	84.0	3.31	38.0	1.50
	K6-S-S-2929	K8-S-S-2929	29	32	1	86.0	3.39	45.5	1.79
	K6-S-S-3636	K8-S-S-3636	36	40	1-1/4	102.0	4.02	57.0	2.68
	K6-S-S-4848	K8-S-S-4848	48	50	1-1/2	115.0	4.53	68.0	2.68

KTR Conduit Reducer

TEARFLX



- Locking device system provides a quick and secure push-in connection of corrugated conduits
- High-grade formulated polyamide
- Self-extinguishing, free from halogens and cadmium
- Temperature range: -40°C(-40°F) to 105°C(221°F)
- Short-term to 160°C(320°F)
- Up to IP68 / NEMA 6P protection with the reinforced sealing cap at conduit side

IP RATING	SHAPE	NW2
K8-TR-1712		
COLOUR MATERIAL	SÉRIES TYPE	NW1

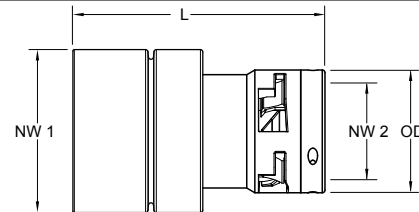

Specifications are subject to change without notice

	Order No.	Order No.	Fits to Conduit		L		OD	
	IP66	IP68	NW 1	NW 2	mm	in	mm	in
	K6-TR-1007	K8-TR-1007	10	7	49.5	1.95	17.0	0.67
	K6-TR-1210	K8-TR-1210	12	10	54.5	2.15	20.0	0.79
	K6-TR-1710	K8-TR-1710	17	10	50.5	1.99	20.0	0.79
	K6-TR-2310	K8-TR-2310	23	10	54.5	2.15	20.0	0.79
	K6-TR-2910	K8-TR-2910	29	10	54.0	2.13	20.0	0.79
	K6-TR-1712	K8-TR-1712	17	12	53.5	2.11	24.0	0.94
	K6-TR-2312	K8-TR-2312	23	12	57.5	2.26	24.0	0.94
	K6-TR-2912	K8-TR-2912	29	12	57.0	2.24	24.0	0.94
	K6-TR-2317	K8-TR-2317	23	17	59.0	2.32	30.0	1.18
	K6-TR-2917	K8-TR-2917	29	17	58.5	2.30	30.0	1.18
	K6-TR-2923	K8-TR-2923	29	23	67.5	2.66	38.0	1.50
	K6-TR-3623	K8-TR-3623	36	23	74.0	2.91	38.0	1.50
	K6-TR-3629	K8-TR-3629	36	29	75.0	2.95	45.5	1.79
	K6-TR-4829	K8-TR-4829	48	29	78.0	3.07	45.5	1.79
	K6-TR-4836	K8-TR-4836	48	36	86.0	3.39	57.0	2.24



- Provides practical, economic and secure connection to pipes
- Locking device system provides a quick and secure push-in connection of corrugated conduits
- High-grade formulated polyamide
- Self-extinguishing, free from halogens and cadmium
- Excellent impact strength
- Temperature range: -40°C(-40°F) to 105°C(221°F)
- Short-term to 160°C(320°F)
- Content of delivery: Conduit splice connector with tube clamp
- Up to IP68 / NEMA 6P protection with the reinforced sealing cap at conduit side

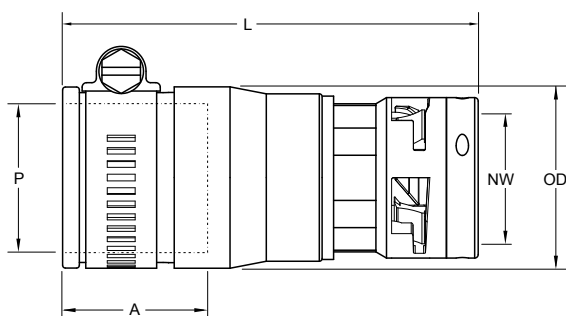

IP RATING	SHAPE	TRADE TYPE	PIPE TYPE
K8	PC	S	17N06
COLOUR MATERIAL	SÉRIES TYPE	NW	TRADE SIZE

Specifications are subject to change without notice

Custom Design to fit (PVC) Polyvinyl chloride Electrical Conduit / (RMC) Rigid Metal Conduit / (GRC) Galvanized Rigid Conduit

Order No.	Fits to Conduit		Fits to Pipe		A		P		L		OD	
	NW	Trade Size	mm	in	mm	in	mm	in	mm	in	mm	in
IP68												
K8-PC-S-17N02-PVC	17	1/2	30.0	1.18	21.5	0.85	83.0	3.27	30.0	1.18		
K8-PC-S-23N04-PVC	23	3/4	30.0	1.18	26.6	1.05	93.0	3.66	40.0	1.57		
K8-PC-S-29N06-PVC	29	1	30.0	1.18	33.5	1.32	97.0	3.82	40.5	1.59		
K8-PC-S-36N07-PVC	36	1-1/4	36.0	1.42	42.5	1.67	116.0	4.57	49.5	1.95		
K8-PC-S-48N08-PVC	48	1-1/2	36.0	1.42	48.5	1.91	123.0	4.84	55.5	2.19		
K8-PC-S-48N09-PVC	48	2	36.0	1.42	60.5	2.38	123.0	4.84	67.5	2.66		

Custom Design to fit (EMT) Electrical Metal Tubing

Order No.	Fits to Conduit		Fits to Pipe		A		P		L		OD	
	NW	Trade Size	mm	in	mm	in	mm	in	mm	in	mm	in
IP68												
K8-PC-S-17N02-EMT	17	1/2	30.0	1.18	18.0	0.71	83.0	3.27	25.0	0.98		
K8-PC-S-23N04-EMT	23	3/4	30.0	1.18	23.5	0.93	93.0	3.66	30.5	1.20		
K8-PC-S-29N06-EMT	29	1	30.0	1.18	29.5	1.16	97.0	3.82	36.5	1.44		
K8-PC-S-36N07-EMT	36	1-1/4	36.0	1.42	38.5	1.52	116.0	4.57	45.5	1.79		
K8-PC-S-48N08-EMT	48	1-1/2	36.0	1.42	44.5	1.75	123.0	4.84	51.5	2.03		
K8-PC-S-48N09-EMT	48	2	36.0	1.42	56.0	2.20	123.0	4.84	63.0	2.48		

Custom Design to fit Imperial Nominal Dimension Industrial Pipes

Order No.	Fits to Conduit			Fits to Pipe	A		L		OD	
	NW	mm	in	P	mm	in	mm	in	mm	in
IP68										
K8-PC-S-10N07	10	12	5/16	1-1/4"	30.0	1.18	75.4	2.97	39.0	1.54
K8-PC-S-12N07	12	16	3/8	1-1/4"	30.0	1.18	80.0	3.15	39.0	1.54
K8-PC-S-17N06	17	20	1/2	1"	30.0	1.18	80.4	3.17	32.5	1.28
K8-PC-S-36N08	36	40	1-1/4	1-1/2"	36.0	1.42	111.0	4.37	58.0	2.28



- Locking device system provides a quick and secure push-in connection of corrugated conduits
- High-grade formulated polyamide
- Self-extinguishing, free from halogens and cadmium
- Excellent impact strength
- Temperature range: -40°C(-40°F) to 105°C(221°F)
- Short-term to 160°C(320°F)
- Up to IP68 / NEMA 6P protection with the reinforced sealing cap at conduit side
- Colour: Black standard, other colours available upon request

TEAFLEX

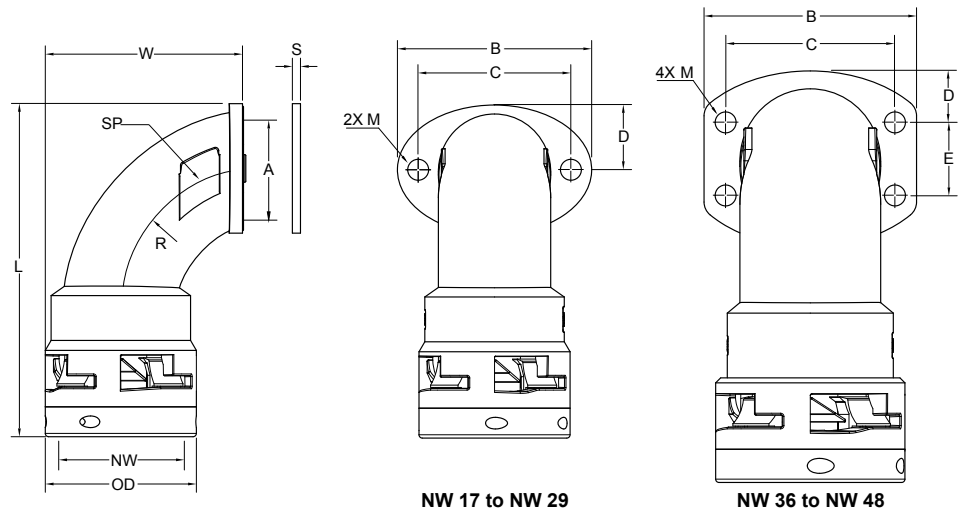
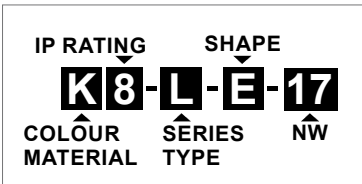

Specifications are subject to change without notice

Order No. IP66	Order No. IP68	Fits to Conduit			A		B		C		D		E		L	
		NW	mm	in	mm	in	mm	in	mm	in	mm	in	mm	in	mm	in
K6-L-E-17	K8-L-E-17	17	20	1/2	16.4	0.65	40.0	1.57	29.5	1.16	12.5	0.49	-	-	74.5	2.93
K6-L-E-23	K8-L-E-23	23	25	3/4	21.7	0.85	53.0	2.09	40.0	1.57	17.0	0.67	-	-	89.5	3.52
K6-L-E-29	K8-L-E-29	29	32	1	29.1	1.15	58.5	2.30	46.0	1.81	19.5	0.77	-	-	100.3	3.95
K6-L-E-36	K8-L-E-36	36	40	1-1/4	36.0	1.42	64.0	2.52	51.0	2.01	15.5	0.85	22.0	0.87	124.0	4.88
K6-L-E-48	K8-L-E-48	48	50	1-1/2	47.8	1.88	78.0	3.07	64.0	2.52	19.5	0.77	26.0	1.02	141.4	5.57

Order No. IP66	Order No. IP68	Fits to Conduit			R		S		W		OD		SP		M	
		NW	mm	in	mm	in	mm	in	mm	in	mm	in	mm	in	mm	in
K6-L-E-17	K8-L-E-17	17	20	1/2	36.6	1.44	3.0	0.12	44.7	1.76	30.0	1.18	20.0	0.79	5.0	0.20
K6-L-E-23	K8-L-E-23	23	25	3/4	41.5	1.63	3.0	0.12	50.7	2.00	38.0	1.50	26.0	1.02	6.0	0.24
K6-L-E-29	K8-L-E-29	29	32	1	47.5	1.87	3.0	0.12	59.4	2.34	45.5	1.79	32.0	1.26	6.0	0.24
K6-L-E-36	K8-L-E-36	36	40	1-1/4	59.4	2.34	3.0	0.12	74.0	2.91	57.0	0.00	40.0	1.57	6.0	0.24
K6-L-E-48	K8-L-E-48	48	50	1-1/2	63.3	2.49	3.0	0.12	82.5	3.25	68.0	2.68	55.0	2.17	6.0	0.24

TEAFLEX



- Locking device system provides a quick and secure push-in connection of corrugated conduits
- High-grade formulated polyamide
- Self-extinguishing, free from halogens and cadmium
- Excellent impact strength
- Temperature range: -40°C(-40°F) to 105°C(221°F)
- Short-term to 160°C(320°F)
- Up to IP68 / NEMA 6P protection with the reinforced sealing cap at conduit side
- Colour: Black standard, other colours available upon request

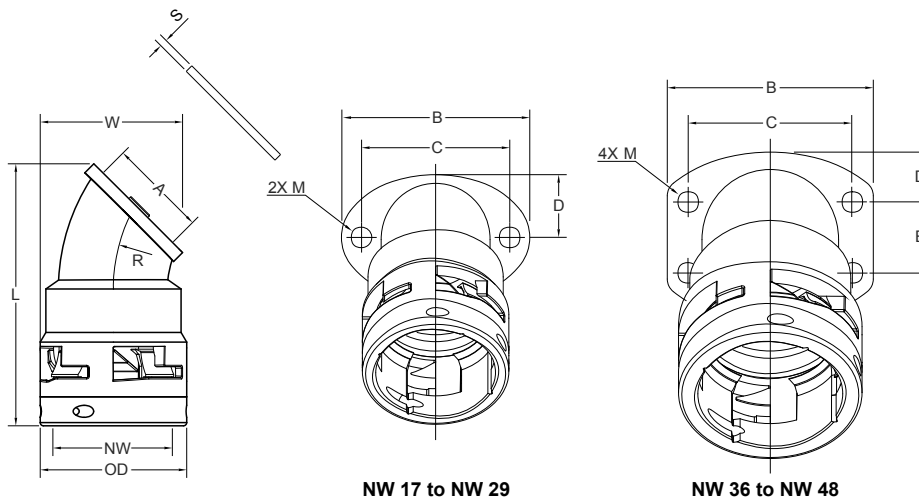

IP RATING	SHAPE
K8-L-F-17	
COLOUR MATERIAL	SÉRIES TYPE
	NW

Specifications are subject to change without notice

Order No.	Order No.	Fits to Conduit			A		B		C		D		E		L	
IP66	IP68	NW	mm	in	mm	in	mm	in	mm	in	mm	in	mm	in	mm	in
K6-L-F-17	K8-L-F-17	17	20	1/2	16.4	0.65	40.0	1.57	29.5	1.16	12.5	0.49	-	-	60.0	2.36
K6-L-F-23	K8-L-F-23	23	25	3/4	21.8	0.86	53.0	2.09	40.0	1.57	17.0	0.67	-	-	75.0	2.95
K6-L-F-29	K8-L-F-29	29	32	1	29.1	1.15	58.5	2.30	46.0	1.81	19.5	0.77	-	-	81.4	3.20
K6-L-F-36	K8-L-F-36	36	40	1-1/4	36.0	1.42	64.0	2.52	51.0	2.01	15.5	0.00	22.0	0.87	97.3	3.83
K6-L-F-48	K8-L-F-48	48	50	1-1/2	47.8	1.88	78.0	3.07	64.0	2.52	19.5	0.77	26.0	1.02	115.0	4.53

Order No.	Order No.	Fits to Conduit			R		S		W		OD		M	
IP66	IP68	NW	mm	in	mm	in	mm	in	mm	in	mm	in	mm	in
K6-L-F-17	K8-L-F-17	17	20	1/2	37.6	1.48	3.0	0.12	35.5	1.40	30.0	1.18	5.0	0.20
K6-L-F-23	K8-L-F-23	23	25	3/4	41.5	1.63	3.0	0.12	37.6	1.48	38.0	1.50	6.0	0.24
K6-L-F-29	K8-L-F-29	29	32	1	47.5	1.87	3.0	0.12	44.2	1.74	45.5	1.79	6.0	0.24
K6-L-F-36	K8-L-F-36	36	40	1-1/4	59.4	2.34	3.0	0.12	56.6	2.23	57.0	0.00	6.0	0.24
K6-L-F-48	K8-L-F-48	48	50	1-1/2	63.3	2.49	3.0	0.12	67.2	2.65	68.0	2.68	6.0	0.24

TRAFLEX



- High-grade formulated polyamide
- Self-extinguishing, free from halogens and cadmium
- Excellent impact strength
- Temperature range: -40°C(-40°F) to 105°C(221°F), Short-term to 160°C(320°F)
- IP65: Fitting with, **RFS** Flat Seal (Conduit Side), **RJG** Flat Gasket (Flange Side)
- IP68: Fitting with, **AC** Sealing Cap (Conduit Side), **RJG** Flat Gasket (Flange Side)

IP RATING SHAPE
K5-L-E-95
 COLOUR SÉRIES NŴ
 MATERIAL TYPE

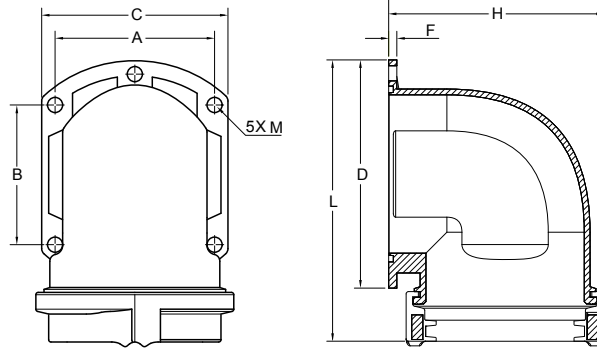

Specifications are subject to change without notice

Order No. IP65	Order No. IP68	Fits to Conduit			A		B		C		D		F		H		L		M
		NW	mm	in	mm	in	mm	in	mm	in	mm	in	mm	in	mm	in	mm	in	mm
K5-L-E-56	K8-L-E-56	56	63	2	68.5	2.70	60.0	2.36	80.0	3.15	98.0	3.86	3.5	0.14	92.0	3.62	121.0	4.76	6.0
K5-L-E-70	K8-L-E-70	70	80	2-1/2-3	80.0	3.15	60.0	2.36	94.5	3.72	111.5	4.39	4.0	0.16	106.5	4.19	132.0	5.20	6.0
K5-L-E-95	K8-L-E-95	95	106	3-1/2-4	108.0	4.25	74.0	2.91	123.5	4.86	145.0	5.71	5.0	0.20	141.0	5.55	172.0	6.77	6.0

KLS

Jumbo, Polyamide Flange Connector

TRAFLEX



- High-grade formulated polyamide
- Self-extinguishing, free from halogens and cadmium
- Excellent impact strength
- Temperature range: -40°C(-40°F) to 105°C(221°F), Short-term to 160°C(320°F)
- IP65: Fitting with, **RFS** Flat Seal (Conduit Side), **RJG** Flat Gasket (Flange Side)
- IP68: Fitting with, **AC** Sealing Cap (Conduit Side), **RJG** Flat Gasket (Flange Side)

IP RATING SHAPE
K5-L-S-95
 COLOUR SÉRIES NŴ
 MATERIAL TYPE

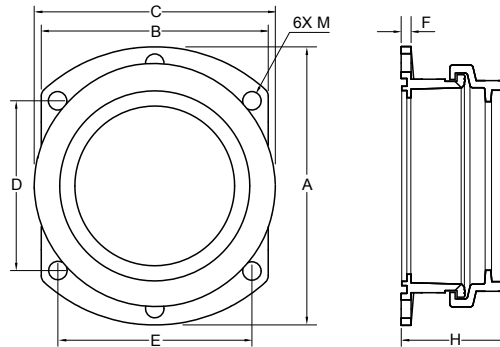

Specifications are subject to change without notice

Order No. IP65	Order No. IP68	Fits to Conduit			A		B		C		D		E		F		H		M
		NW	mm	in	mm	in	mm	in	mm	in	mm	in	mm	in	mm	in	mm	in	mm
K5-L-S-56	K8-L-S-56	56	63	2	98.0	3.86	80.0	3.15	85.0	3.35	60.0	2.36	68.5	2.70	3.5	0.14	38.0	1.50	6.0
K5-L-S-70	K8-L-S-70	70	80	2-1/2-3	111.0	4.37	94.5	3.72	99.4	3.91	60.0	2.36	80.0	3.15	4.0	0.16	43.0	1.69	6.0
K5-L-S-95	K8-L-S-95	95	106	3-1/2-4	145.0	5.71	123.5	4.86	129.0	5.08	74.0	2.91	108.0	4.25	5.0	0.20	48.5	1.91	6.0



- Integrated anchorage, wide sealing and clamping range, easy to install
- Polyamide PA6 V-2 Dome nut & Gland body
- Polychloroprene-Nitrile rubber CR/NBR Sealing ring
- IP 68 up to 10 bar to the cable and pressure screw
- Temperature range: -20°C (-4°F) to 100°C (-212°F)
- Test standard: EN 50262 / UL 514B

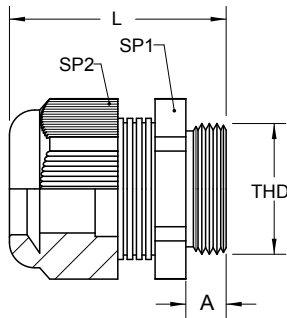

IP RATING SERIES THD. SIZE

K8-GX-J-M16-10

COLOUR MATERIAL TYPE THD. TYPE MAX. CABLE RANGE

GXL ← LONG THREAD

GXR ← REDUCER

Specifications are subject to change without notice

METRIC
THREAD

CONNECTING THREAD-STANDARD LENGTH										
Order No.	THD	Cable Range	A		SP1		SP2		L	
IP68	Metric	mm	mm	in	mm	in	mm	in	mm	in
K8-GX-J-M12-6.5	M12x1.5	3-6.5	8.0	0.31	15.0	0.59	15.0	0.59	31.0	1.22
K8-GX-J-M16-10	M16x1.5	5-10	8.0	0.31	22.0	0.87	22.0	0.87	37.0	1.46
K8-GX-J-M20-14	M20x1.5	10-14	8.0	0.31	27.0	1.06	27.0	1.06	40.5	1.59
K8-GX-J-M25-18	M25x1.5	13-18	8.0	0.31	33.0	1.30	33.0	1.30	45.0	1.77
K8-GX-J-M32-25	M32x1.5	18-25	10.0	0.39	42.0	1.65	42.0	1.65	52.5	2.07
K8-GX-J-M40-32	M40x1.5	22-32	10.0	0.39	53.0	2.09	53.0	2.09	61.5	2.42
K8-GX-J-M50-38	M50x1.5	30-38	12.0	0.47	60.0	2.36	60.0	2.36	67.5	2.66
K8-GX-J-M63-44	M63x1.5	34-44	12.0	0.47	65.0	2.56	65.0	2.56	67.0	2.64
CONNECTING THREAD-LONG										
K8-GXL-J-M12-6.5	M12x1.5	3-6.5	8.0	0.31	15.0	0.59	15.0	0.59	31.0	1.22
K8-GXL-J-M16-10	M16x1.5	5-10	15.0	0.59	22.0	0.87	22.0	0.87	44.0	1.73
K8-GXL-J-M20-14	M20x1.5	10-14	15.0	0.59	27.0	1.06	27.0	1.06	47.5	1.87
K8-GXL-J-M25-18	M25x1.5	13-18	15.0	0.59	33.0	1.30	33.0	1.30	52.0	2.05
K8-GXL-J-M32-25	M32x1.5	18-25	15.0	0.59	42.0	1.65	42.0	1.65	57.0	2.24
K8-GXL-J-M40-32	M40x1.5	22-32	18.0	0.71	53.0	2.09	53.0	2.09	69.0	2.72
K8-GXL-J-M50-38	M50x1.5	30-38	18.0	0.71	60.0	2.36	60.0	2.36	73.5	2.89
K8-GXL-J-M63-44	M63x1.5	34-44	18.0	0.71	65.0	2.56	65.0	2.56	73.0	2.87
REDUCING SEALING RING FOR SMALL CABLE DIAMETER										
K8-GXR-J-M12-5	M12x1.5	2-5	8.0	0.31	15.0	0.59	15.0	0.59	31.0	1.22
K8-GXR-J-M16-7	M16x1.5	3-7	15.0	0.59	22.0	0.87	22.0	0.87	44.0	1.73
K8-GXR-J-M20-12	M20x1.5	7-12	15.0	0.59	27.0	1.06	27.0	1.06	47.5	1.87
K8-GXR-J-M25-16	M25x1.5	9-16	15.0	0.59	33.0	1.30	33.0	1.30	52.0	2.05
K8-GXR-J-M32-20	M32x1.5	12-20	15.0	0.59	42.0	1.65	42.0	1.65	57.0	2.24
K8-GXR-J-M40-26	M40x1.5	20-26	18.0	0.71	53.0	2.09	53.0	2.09	69.0	2.72
K8-GXR-J-M50-31	M50x1.5	25-31	18.0	0.71	60.0	2.36	60.0	2.36	73.5	2.89
K8-GXR-J-M63-35	M63x1.5	29-35	18.0	0.71	65.0	2.56	65.0	2.56	73.0	2.87



- Integrated anchorage, wide sealing and clamping range, easy to install
- Polyamide PA6 V-2 Dome nut & Gland body
- Polychloroprene-Nitrile rubber CR/NBR Sealing ring
- IP 68 up to 10 bar to the cable and pressure screw
- Temperature range: -20°C (-4°F) to 100°C (-212°F)
- Test standard: EN 50262 / UL 514B

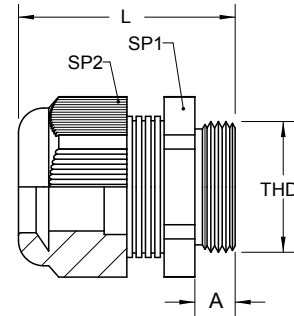
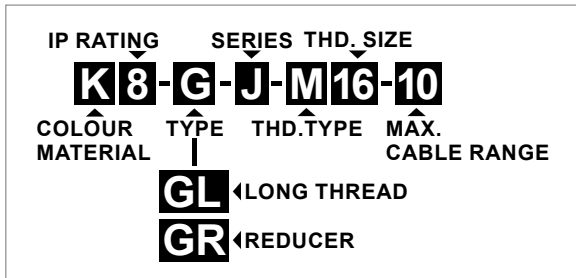

Specifications are subject to change without notice

**METRIC
THREAD**

CONNECTING THREAD-STANDARD LENGTH										
Order No.	THD	Cable Range	A		SP1		SP2		L	
IP68	Metric	mm	mm	in	mm	in	mm	in	mm	in
K8-G-J-M12-6	M12x1.5	3-6	8.0	0.31	15.0	0.59	15.0	0.59	31.0	1.22
K8-G-J-M16-10	M16x1.5	5-10	8.0	0.31	20.0	0.79	20.0	0.79	35.5	1.40
K8-G-J-M20-13	M20x1.5	8-13	8.0	0.31	24.0	0.94	24.0	0.94	36.0	1.42
K8-G-J-M25-17	M25x1.5	11-17	8.0	0.31	29.0	1.14	29.0	1.14	43.0	1.69
K8-G-J-M32-21	M32x1.5	15-21	10.0	0.39	36.0	1.42	36.0	1.42	50.0	1.97
K8-G-J-M40-28	M40x1.5	19-28	10.0	0.39	46.0	1.81	46.0	1.81	51.0	2.01
K8-G-J-M50-35	M50x1.5	27-35	12.0	0.47	55.0	2.17	55.0	2.17	61.5	2.42
K8-G-J-M63-42	M63x1.5	32-42	12.0	0.47	68.0	2.68	68.0	2.68	65.5	2.58
CONNECTING THREAD-LONG										
K8-GL-J-M12-6	M12x1.5	3-6	15.0	0.59	15.0	0.59	15.0	0.59	38.0	1.50
K8-GL-J-M16-10	M16x1.5	5-10	15.0	0.59	20.0	0.79	20.0	0.79	42.5	1.67
K8-GL-J-M20-13	M20x1.5	8-13	15.0	0.59	24.0	0.94	24.0	0.94	43.0	1.69
K8-GL-J-M25-17	M25x1.5	11-17	15.0	0.59	29.0	1.14	29.0	1.14	50.0	1.97
K8-GL-J-M32-21	M32x1.5	15-21	15.0	0.59	36.0	1.42	36.0	1.42	55.0	2.17
K8-GL-J-M40-28	M40x1.5	19-28	18.0	0.71	46.0	1.81	46.0	1.81	59.0	2.32
K8-GL-J-M50-35	M50x1.5	27-35	18.0	0.71	55.0	2.17	55.0	2.17	67.5	2.66
K8-GL-J-M63-42	M63x1.5	32-42	18.0	0.71	68.0	2.68	68.0	2.68	71.5	2.81
REDUCING SEALING RING FOR SMALL CABLE DIAMETER										
K8-GR-J-M12-5	M12x1.5	2-5	8.0	0.31	15.0	0.59	15.0	0.59	31.0	1.22
K8-GR-J-M16-10	M16x1.5	3-10	8.0	0.31	20.0	0.79	20.0	0.79	35.5	1.40
K8-GR-J-M20-13	M20x1.5	5-13	8.0	0.31	24.0	0.94	24.0	0.94	36.0	1.42
K8-GR-J-M25-17	M25x1.5	8-17	8.0	0.31	29.0	1.14	29.0	1.14	43.0	1.69
K8-GR-J-M32-21	M32x1.5	12-21	10.0	0.39	36.0	1.42	36.0	1.42	50.0	1.97
K8-GR-J-M40-28	M40x1.5	16-28	10.0	0.39	46.0	1.81	46.0	1.81	51.0	2.01
K8-GR-J-M50-35	M50x1.5	21-35	12.0	0.47	55.0	2.17	55.0	2.17	61.5	2.42
K8-GR-J-M63-42	M63x1.5	27-48	12.0	0.47	68.0	2.68	68.0	2.68	65.5	2.58

CONNECTING THREAD-STANDARD LENGTH										
Order No.	THD	Cable Range	A		SP1		SP2		L	
IP68	NPT	mm	mm	in	mm	in	mm	in	mm	in
K8-G-J-N01-10	3/8	5-10	15.5	0.61	22.0	0.87	22.0	0.87	44.5	1.75
K8-G-J-N02-12	1/2	6-12	14.5	0.57	24.0	0.94	24.0	0.94	45.0	1.77
K8-G-J-N02-14	1/2	10-14	15.0	0.59	27.0	1.06	27.0	1.06	47.5	1.87
K8-G-J-N04-18	3/4	14-18	15.0	0.59	33.0	1.30	33.0	1.30	52.0	2.05
K8-G-J-N06-25	1	19-25	18.0	0.71	42.0	1.65	42.0	1.65	60.5	2.38
K8-G-J-N07-32	1-1/4	22-32	18.0	0.71	53.0	2.09	53.0	2.09	69.5	2.74
REDUCING SEALING RING FOR SMALL CABLE DIAMETER										
K8-GR-J-N01-7	3/8	3-7	15.5	0.61	22.0	0.87	22.0	0.87	44.5	1.75
K8-GR-J-N02-9	1/2	5-9	14.5	0.57	24.0	0.94	24.0	0.94	45.0	1.77
K8-GR-J-N02-12	1/2	7-12	15.0	0.59	27.0	1.06	27.0	1.06	47.5	1.87
K8-GR-J-N04-16	3/4	9-16	15.0	0.59	33.0	1.30	33.0	1.30	52.0	2.05
K8-GR-J-N06-20	1	12-20	18.0	0.71	42.0	1.65	42.0	1.65	60.5	2.38
K8-GR-J-N07-26	1-1/4	20-26	18.0	0.71	53.0	2.09	53.0	2.09	69.5	2.74

CONNECTING THREAD-STANDARD LENGTH										
Order No.	THD	Cable Range	A		SP1		SP2		L	
IP68	Metric	mm	mm	in	mm	in	mm	in	mm	in
K8-G-J-P07-6.5	7	3-6.5	8.0	0.31	15.0	0.59	15.0	0.59	30.5	1.20
K8-G-J-P09-8	9	4-8	8.0	0.31	19.0	0.75	19.0	0.75	34.0	1.34
K8-G-J-P11-10	11	5-10	8.0	0.31	22.0	0.87	22.0	0.87	37.0	1.46
K8-G-J-P13-12	13.5	6-12	9.0	0.35	24.0	0.94	24.0	0.94	39.0	1.54
K8-G-J-P16-14	16	10-14	10.0	0.39	27.0	1.06	27.0	1.06	42.5	1.67
K8-G-J-P21-18	21	13-18	11.0	0.43	33.0	1.30	33.0	1.30	47.5	1.87
K8-G-J-P29-25	29	18-25	11.0	0.43	42.0	1.65	42.0	1.65	53.0	2.09
K8-G-J-P36-32	36	22-32	13.0	0.51	53.0	2.09	53.0	2.09	61.0	2.40
K8-G-J-P42-38	42	30-38	13.0	0.51	60.0	2.36	60.0	2.36	65.0	2.56
K8-G-J-P48-44	48	34-44	14.0	0.55	65.0	2.56	65.0	2.56	67.0	2.64
CONNECTING THREAD-LONG										
K8-GL-J-P07-6.5	7	3-6.5	15.0	0.59	15.0	0.59	15.0	0.59	37.5	1.48
K8-GL-J-P09-8	9	4-8	15.0	0.59	19.0	0.75	19.0	0.75	41.0	1.61
K8-GL-J-P11-10	11	5-10	15.0	0.59	22.0	0.87	22.0	0.87	44.0	1.73
K8-GL-J-P13-12	13.5	6-12	15.0	0.59	24.0	0.94	24.0	0.94	45.0	1.77
K8-GL-J-P16-14	16	10-14	15.0	0.59	27.0	1.06	27.0	1.06	47.5	1.87
K8-GL-J-P21-18	21	13-18	15.0	0.59	33.0	1.30	33.0	1.30	51.5	2.03
K8-GL-J-P29-25	29	18-25	15.0	0.59	42.0	1.65	42.0	1.65	57.0	2.24
K8-GL-J-P36-32	36	22-32	18.0	0.71	53.0	2.09	53.0	2.09	66.0	2.60
REDUCING SEALING RING FOR SMALL CABLE DIAMETER										
K8-GR-J-P07-5	7	2-5	8.0	0.31	15.0	0.59	15.0	0.59	30.5	1.20
K8-GR-J-P09-6	9	2-6	8.0	0.31	19.0	0.75	19.0	0.75	34.0	1.34
K8-GR-J-P11-7	11	3-7	8.0	0.31	22.0	0.87	22.0	0.87	37.0	1.46
K8-GR-J-P13-9	13.5	5-9	9.0	0.35	24.0	0.94	24.0	0.94	39.0	1.54
K8-GR-J-P16-12	16	7-12	10.0	0.39	27.0	1.06	27.0	1.06	42.5	1.67
K8-GR-J-P21-16	21	9-16	11.0	0.43	33.0	1.30	33.0	1.30	47.5	1.87
K8-GR-J-P29-20	29	12-20	11.0	0.43	42.0	1.65	42.0	1.65	53.0	2.09
K8-GR-J-P36-26	36	20-26	13.0	0.51	53.0	2.09	53.0	2.09	61.0	2.40



- Integrated anchorage, wide sealing and clamping range, easy to install
- Protection against twisting
- Nickel-plated brass Dome nut & Gland body
- Polychloroprene-Nitrile rubber CR/NBR Sealing ring
- IP 68 up to 10 bar to the cable and pressure screw
- Temperature range: -20°C (-4°F) to 100°C (-212°F)
- Test standard: EN 50262 / UL 514B

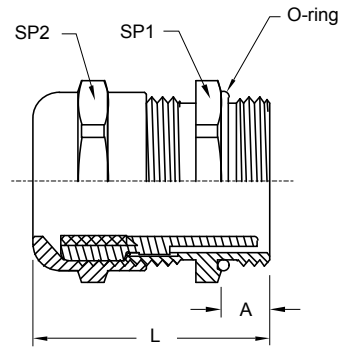
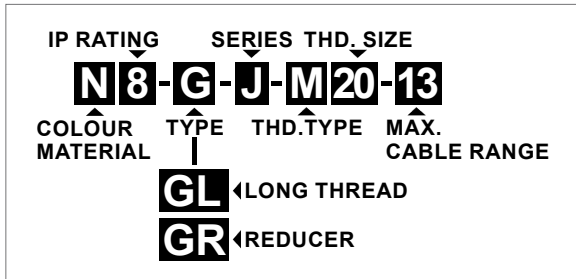

Specifications are subject to change without notice

METRIC METAL THREAD

CONNECTING THREAD-STANDARD LENGTH										
Order No.	THD	Cable Range	A		SP1		SP2		L	
IP68	Metric	mm	mm	in	mm	in	mm	in	mm	in
N8-G-J-M12-6	M12x1.5	3-6	5.0	0.20	14.0	0.55	14.0	0.55	25.0	0.98
N8-G-J-M16-9	M16x1.5	5-9	5.0	0.20	17.0	0.67	17.0	0.67	30.0	1.18
N8-G-J-M20-13	M20x1.5	9-13	6.0	0.24	22.0	0.87	22.0	0.87	33.5	1.32
N8-G-J-M25-16	M25x1.5	11-16	7.0	0.28	27.0	1.06	27.0	1.06	36.5	1.44
N8-G-J-M32-21	M32x1.5	14-21	8.0	0.31	34.0	1.34	34.0	1.34	38.0	1.50
N8-G-J-M40-27	M40x1.5	19-27	8.0	0.31	43.0	1.69	43.0	1.69	41.0	1.61
N8-G-J-M50-35	M50x1.5	24-35	9.0	0.35	55.0	2.17	55.0	2.17	49.5	1.95
N8-G-J-M63-42	M63x1.5	32-42	10.0	0.39	65.0	2.56	65.0	2.56	52.5	2.07
N8-G-J-M63-48	M63x1.5	38-48	10.0	0.39	65.0	2.56	65.0	2.56	52.5	2.07
CONNECTING THREAD-LONG										
N8-GL-J-M12-6	M12x1.5	3-6	10.0	0.39	14.0	0.55	14.0	0.55	30.0	1.18
N8-GL-J-M16-9	M16x1.5	5-9	10.0	0.39	17.0	0.67	17.0	0.67	35.0	1.38
N8-GL-J-M20-13	M20x1.5	9-13	10.0	0.39	22.0	0.87	22.0	0.87	37.5	1.48
N8-GL-J-M25-16	M25x1.5	11-16	11.0	0.43	27.0	1.06	27.0	1.06	40.5	1.59
N8-GL-J-M32-21	M32x1.5	14-21	13.0	0.51	34.0	1.34	34.0	1.34	43.0	1.69
N8-GL-J-M40-27	M40x1.5	19-27	13.0	0.51	43.0	1.69	43.0	1.69	46.0	1.81
N8-GL-J-M50-35	M50x1.5	24-35	14.0	0.55	55.0	2.17	55.0	2.17	54.5	2.15
N8-GL-J-M63-42	M63x1.5	32-42	14.0	0.55	65.0	2.56	65.0	2.56	56.5	2.22
N8-GL-J-M63-48	M63x1.5	38-48	14.0	0.55	65.0	2.56	65.0	2.56	56.5	2.22
REDUCING SEALING RING FOR SMALL CABLE DIAMETER										
N8-GR-J-M12-5	M12x1.5	2-5	5.0	0.20	14.0	0.55	14.0	0.55	25.0	0.98
N8-GR-J-M16-9	M16x1.5	3-9	5.0	0.20	17.0	0.67	17.0	0.67	30.0	1.18
N8-GR-J-M20-13	M20x1.5	5-13	6.0	0.24	22.0	0.87	22.0	0.87	33.5	1.32
N8-GR-J-M25-16	M25x1.5	8-16	7.0	0.28	27.0	1.06	27.0	1.06	36.5	1.44
N8-GR-J-M32-21	M32x1.5	12-21	8.0	0.31	34.0	1.34	34.0	1.34	38.0	1.50
N8-GR-J-M40-27	M40x1.5	16-27	8.0	0.31	43.0	1.69	43.0	1.69	41.0	1.61
N8-GR-J-M50-35	M50x1.5	21-35	9.0	0.35	55.0	2.17	55.0	2.17	49.5	1.95
N8-GR-J-M63-48	M63x1.5	27-48	10.0	0.39	65.0	2.56	65.0	2.56	52.5	2.07

CONNECTING THREAD-STANDARD LENGTH										
Order No.	THD	Cable Range	A		SP1		SP2		L	
IP68	NPT	mm	mm	in	mm	in	mm	in	mm	in
N8-G-L-N00-7	1/4	3.5-7	15.0	0.59	16.0	0.63	16.0	0.63	36.0	1.42
N8-G-L-N01-10	3/8	4.5-10	15.0	0.59	20.0	0.79	20.0	0.79	39.7	1.56
N8-G-L-N02-13	1/2	7-13	15.0	0.59	24.0	0.94	24.0	0.94	42.5	1.67
N8-G-L-N04-17	3/4	9-17	15.0	0.59	29.0	1.14	29.0	1.14	44.5	1.75
N8-G-L-N06-21	1	11-21	17.0	0.67	36.0	1.42	36.0	1.42	49.0	1.93
N8-G-L-N07-28	1 1/4	19-28	17.0	0.67	45.0	1.77	45.0	1.77	57.5	2.26
N8-G-L-N08-35	1 1/2	27-35	17.0	0.67	54.0	2.13	54.0	2.13	61.5	2.42
N8-G-L-N09-45	2	34-45	17.0	0.67	67.0	2.64	67.0	2.64	63.5	2.50
REDUCING SEALING RING FOR SMALL CABLE DIAMETER										
N8-GR-L-N00-5	1/4	1-5	15.0	0.59	16.0	0.63	16.0	0.63	36.0	1.42
N8-GR-L-N01-7	3/8	2-7	15.0	0.59	20.0	0.79	20.0	0.79	39.7	1.56
N8-GR-L-N02-10	1/2	5-10	15.0	0.59	24.0	0.94	24.0	0.94	42.5	1.67
N8-GR-L-N04-13	3/4	6-13	15.0	0.59	29.0	1.14	29.0	1.14	44.5	1.75
N8-GR-L-N06-15	1	7-15	17.0	0.67	36.0	1.42	36.0	1.42	49.0	1.93
N8-GR-L-N07-23	1 1/4	15-23	17.0	0.67	45.0	1.77	45.0	1.77	57.5	2.26
N8-GR-L-N08-29	1 1/2	22-29	17.0	0.67	54.0	2.13	54.0	2.13	61.5	2.42
N8-GR-L-N09-39	2	28-39	17.0	0.67	67.0	2.64	67	2.64	63.5	2.50

CONNECTING THREAD-STANDARD LENGTH										
Order No.	THD	Cable Range	A		SP1		SP2		L	
IP68	PG	mm	mm	in	mm	in	mm	in	mm	in
N8-G-J-P07-6.5	7	3-6.5	5.0	0.20	14.0	0.55	14.0	0.55	24.0	0.94
N8-G-J-P09-8	9	4-8	6.0	0.24	17.0	0.67	17.0	0.67	29.0	1.14
N8-G-J-P11-10	11	5-10	6.0	0.24	20.0	0.79	20.0	0.79	29.5	1.16
N8-G-J-P13-12	13.5	6-12	6.5	0.26	22.0	0.87	22.0	0.87	31.5	1.24
N8-G-J-P16-14	16	10-14	6.5	0.26	24.0	0.94	24.0	0.94	31.5	1.24
N8-G-J-P21-18	21	13-18	7.0	0.28	30.0	1.18	30.0	1.18	34.0	1.34
N8-G-J-P29-25	29	18-25	8.0	0.31	40.0	1.57	40.0	1.57	39.0	1.54
N8-G-J-P36-32	36	24-32	9.0	0.35	50.0	1.97	50.0	1.97	45.0	1.77
N8-G-J-P42-38	42	30-38	10.0	0.39	57.0	2.24	57.0	2.24	49.0	1.93
N8-G-J-P48-44	48	34-44	10.0	0.39	64.0	2.52	64.0	2.52	52.0	2.05
CONNECTING THREAD-LONG										
N8-GL-J-P07-6.5	7	3-6.5	15.0	0.59	14.0	0.55	14.0	0.55	34.0	1.34
N8-GL-J-P09-8	9	4-8	15.0	0.59	17.0	0.67	17.0	0.67	38.0	1.50
N8-GL-J-P11-10	11	5-10	15.0	0.59	20.0	0.79	20.0	0.79	38.5	1.52
N8-GL-J-P13-12	13.5	6-12	15.0	0.59	22.0	0.87	22.0	0.87	40.0	1.57
N8-GL-J-P16-14	16	10-14	15.0	0.59	24.0	0.94	24.0	0.94	40.0	1.57
N8-GL-J-P21-18	21	13-18	15.0	0.59	30.0	1.18	30.0	1.18	42.0	1.65
N8-GL-J-P29-25	29	18-25	15.0	0.59	40.0	1.57	40.0	1.57	46.0	1.81
REDUCING SEALING RING FOR SMALL CABLE DIAMETER										
N8-GR-J-P07-5	7	2-5	5.0	0.20	14.0	0.55	14.0	0.55	24.0	0.94
N8-GR-J-P09-6	9	2-6	6.0	0.24	17.0	0.67	17.0	0.67	29.0	1.14
N8-GR-J-P11-7	11	3-7	6.0	0.24	20.0	0.79	20.0	0.79	29.5	1.16
N8-GR-J-P13-9	13.5	5-9	6.5	0.26	22.0	0.87	22.0	0.87	31.5	1.24
N8-GR-J-P16-12	16	7-12	6.5	0.26	24.0	0.94	24.0	0.94	31.5	1.24
N8-GR-J-P21-16	21	9-16	7.0	0.28	30.0	1.18	30.0	1.18	34.0	1.34
N8-GR-J-P29-20	29	12-20	8.0	0.31	40.0	1.57	40.0	1.57	39.0	1.54
N8-GR-J-P36-26	36	20-26	9.0	0.35	50.0	1.97	50.0	1.97	45.0	1.77



- High-grade formulated polyamide
- Self-extinguishing, free from halogens and cadmium
- Excellent impact strength
- Temperature range: -40°C(-40°F) to 105°C(221°F)
- Short-term to 160°C(320°F)
- Colour: Black standard, other colours available upon request
- One-piece tube clamp with integrated safety clip
- Especially suitable for reverse overhead installations
- Fits both profile conduits C (Coarse) / F (Fine)
- Fits to support rail TCR

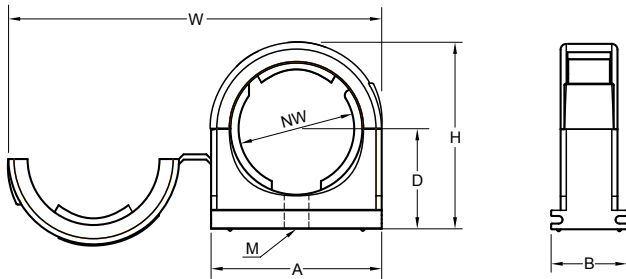

IP RATING		NW	
KX	-C1	17	
COLOUR	SÉRIES	TYPE	
MATERIAL			

Specifications are subject to change without notice

Order No.	Fits to Conduit			A		B		D		H		W		M
	NW	mm	in	mm	in	mm	in	mm	in	mm	in	mm	in	mm
KX-C1-07	7	10	1/4	17.0	0.67	20.0	0.79	13.1	0.52	21.8	0.86	40.0	1.57	4.0
KX-C1-10	10	12	5/6	21.0	0.83	20.0	0.79	15.0	0.59	25.7	1.01	48.0	1.89	5.0
KX-C1-12	12	16	3/8	24.0	0.94	20.0	0.79	16.4	0.65	28.6	1.13	54.0	2.13	5.0
KX-C1-17	17	20	1/2	30.0	1.18	20.0	0.79	19.7	0.78	34.9	1.37	68.0	2.68	6.0
KX-C1-23	23	25	3/4	38.0	1.50	20.0	0.79	23.3	0.92	42.5	1.67	84.0	3.31	6.0
KX-C1-29	29	32	1	45.0	1.77	20.0	0.79	26.4	1.04	49.0	1.93	98.0	3.86	6.0
KX-C1-36	36	40	1-1/4	55.0	2.17	20.0	0.79	30.2	1.19	58.0	2.28	118.0	4.65	6.0
KX-C1-48	48	50	1-1/2	67.5	2.66	20.0	0.79	36.3	1.43	70.3	2.77	143.0	5.63	6.0

TCR Rail for system Support

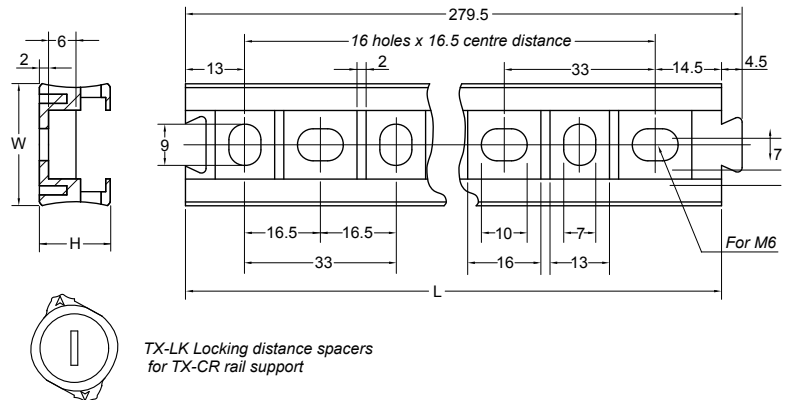
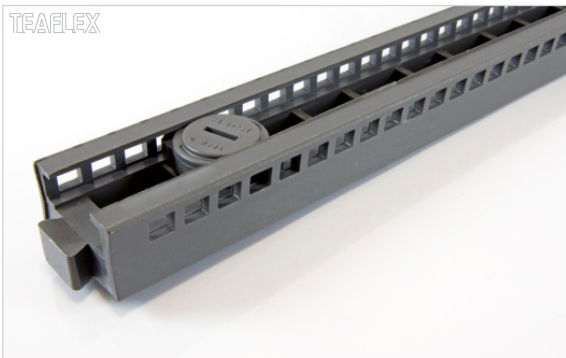

TX-LK Locking distance spacers for TX-CR rail support

Specifications are subject to change without notice

Order No.	Fits to Tube Clamps	L		W		H		M	Order No.	Each CR rail includes 2 locking distance spacers LK series
		mm	in	mm	in	mm	in			
TX-CR	KX-C1-07 to KX-C1-48	275.0	10.83	25.0	0.98	15.5	0.61	M6	TX-LK	



- High-grade formulated polyamide
- Self-extinguishing, free from halogens and cadmium
- Excellent impact strength
- Temperature range: -40°C(-40°F) to 105°C(221°F)
- Short-term to 160°C(320°F)
- Fits both profile conduits C (Coarse) / F (Fine)

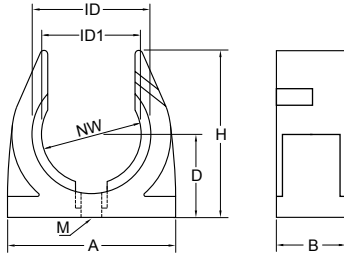

IP RATING **KX-CD-20** NW
 COLOUR MATERIAL **KX-CD-20** SERIES TYPE

Specifications are subject to change without notice

Order No.	Fits to Conduit		A		B		D		H		ID		ID1		M
	NW		mm	in	mm	in	mm	in	mm	in	mm	in	mm	in	
KX-CD-06	6 / 7		15.0	0.59	20.0	0.79	10.0	0.39	17.0	0.67	9.2	0.36	7.8	0.31	3
KX-CD-10	10		18.0	0.71	20.0	0.79	12.0	0.47	21.0	0.83	12.3	0.48	10.3	0.41	3
KX-CD-11	11 / 12		21.0	0.83	20.0	0.79	13.0	0.51	23.0	0.91	14.7	0.58	12.3	0.48	3
KX-CD-14	14		24.0	0.94	20.0	0.79	15.0	0.59	26.0	1.02	17.0	0.67	14.5	0.57	3
KX-CD-16	16 / 17		30.0	1.18	20.0	0.79	18.0	0.71	33.0	1.30	20.5	0.81	18.0	0.71	5
KX-CD-20	20		35.0	1.38	20.0	0.79	20.0	0.79	36.0	1.42	25.0	0.98	22.5	0.89	5
KX-CD-23	23		42.0	1.65	20.0	0.79	24.0	0.94	43.0	1.69	30.0	1.18	26.0	1.02	5
KX-CD-29	29		48.0	1.89	20.0	0.79	25.0	0.98	48.0	1.89	34.0	1.34	29.0	1.14	5
KX-CD-37	37		55.0	2.17	20.0	0.79	30.0	1.18	55.0	2.17	40.0	1.57	34.0	1.34	6
KX-CD-45	45		67.0	2.64	20.0	0.79	36.0	1.42	67.0	2.64	52.0	2.05	46.0	1.81	6
KX-CD-70	70		99.0	3.90	20.0	0.79	50.0	1.97	99.0	3.90	77.0	3.03	67.5	2.66	6

KC6 One-piece Tube Clamp with Integrated Fixed Base



- High-grade formulated polyamide
- Self-extinguishing, free from halogens and cadmium
- Temperature range: -40°C(-40°F) to 105°C(221°F), Short-term to 160°C(320°F)
- Variable assembly options due to six holes fastening
- Totally safe against twisting and movements
- One-piece tube clamp with integrated safety clip
- Especially suitable for reverse overhead installations
- Fits both profile conduits C (Coarse) / F (Fine)

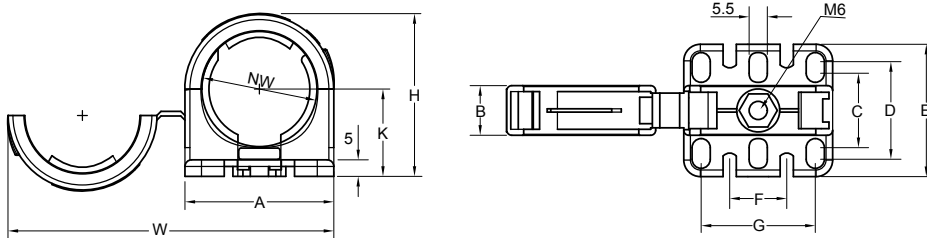

IP RATING **KX-C6-17** NW
 COLOUR MATERIAL **KX-C6-17** SERIES TYPE

Specifications are subject to change without notice

Order No.	Fits to Conduit		A		B		C		D		E		F		G		H		K		W		
	NW		mm	in	mm	in	mm	in	mm	in	mm	in	mm	in	mm	in	mm	in	mm	in	mm	in	
KX-C6-17	17	20	1/2	37.5	1.48	14.0	0.55	20.0	0.79	27.0	1.06	35.0	1.38	13.8	0.54	27.5	1.08	35.0	1.38	19.7	0.78	71.9	2.83
KX-C6-23	23	25	3/4	38.0	1.50	15.0	0.59	22.5	0.89	28.5	1.12	38.5	1.52	14.0	0.55	29.0	1.14	42.5	1.67	23.4	0.92	84.0	3.31
KX-C6-29	29	32	1	45.0	1.77	15.0	0.59	22.5	0.89	29.5	1.16	40.0	1.57	17.3	0.68	34.5	1.36	49.0	1.93	26.4	1.04	98.5	3.88
KX-C6-36	36	40	1-1/4	55.0	2.17	15.0	0.59	24.5	0.96	49.5	1.95	60.0	2.36	21.8	0.86	43.5	1.71	58.0	2.28	30.3	1.19	118.0	4.65
KX-C6-48	48	50	1-1/2	67.5	2.66	15.0	0.59	24.5	0.96	49.5	1.95	60.0	2.36	28.0	1.10	56.0	2.20	70.0	2.76	36.4	1.43	143.0	5.63



- High-grade formulated polyamide
- Self-extinguishing, free from halogens and cadmium
- Excellent impact strength
- Temperature range: -40°C(-40°F) to 105°C(221°F)
- Short-term to 160°C(320°F)
- High stiffness in stackable configuration
- Totally safe against twisting and movements
- Content of delivery: System support with assembling screws
- Fits both profile conduits C (Coarse) / F (Fine)

K0-CB-36
 NW
 COLOUR MATERIAL SÉRIES TYPE

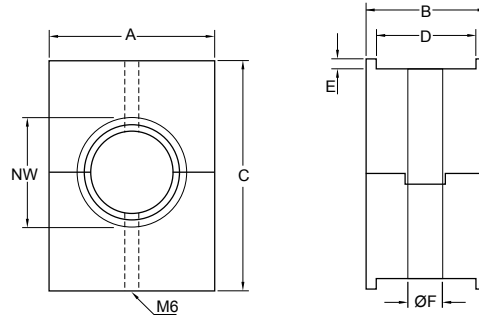

Specifications are subject to change without notice

Order No.	fits to	A		B		C		D		E		Ø F	
	NW	mm	in	mm	in	mm	in	mm	in	mm	in	mm	in
K0-CB-17	17	47.5	1.87	34.5	1.36	66.0	2.60	25.4	1.00	3.1	0.12	10.0	0.39
K0-CB-23	23	47.5	1.87	34.5	1.36	66.0	2.60	25.4	1.00	3.1	0.12	10.0	0.39
K0-CB-29	29	61.5	2.42	34.5	1.36	66.0	2.60	25.4	1.00	3.1	0.12	10.0	0.39
K0-CB-36	36	61.5	2.42	34.5	1.36	66.0	2.60	25.4	1.00	3.1	0.12	10.0	0.39
K0-CB-48	48	76.0	2.99	34.5	1.36	66.0	2.60	25.4	1.00	3.1	0.12	10.0	0.39

KCR One-Piece System Support



- High-grade formulated polyamide
- Self-extinguishing, free from halogens and cadmium
- Excellent impact strength
- Temperature range: -40°C(-40°F) to 105°C(221°F)
- Short-term to 160°C(320°F)

K0-CR-36
 NW
 COLOUR MATERIAL SÉRIES TYPE

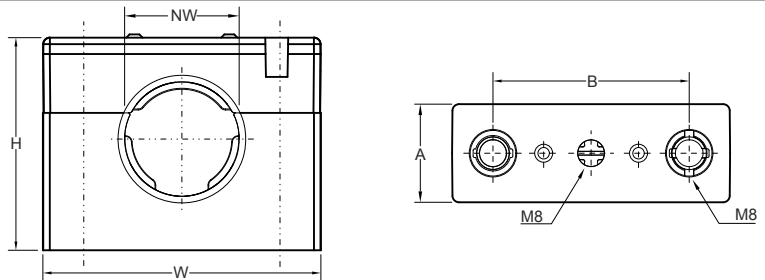

Specifications are subject to change without notice

Order No.	fits to	A		B		H		W	
	NW	mm	in	mm	in	mm	in	mm	in
K0-CR-17	17	30.0	1.18	45.0	1.77	50.0	1.97	70.0	2.76
K0-CR-23	23	30.0	1.18	45.0	1.77	50.0	1.97	70.0	2.76
K0-CR-29	29	30.0	1.18	60.0	2.36	65.0	2.56	85.0	3.35
K0-CR-36	36	30.0	1.18	60.0	2.36	65.0	2.56	85.0	3.35
K0-CR-48	48	30.0	1.18	90.0	3.54	92.0	3.62	115.0	4.53
K0-CR-56	56	30.0	1.18	90.0	3.54	92.0	3.62	115.0	4.53



- Galvanized steel according to DIN 3016
- Elastometer is free from halogens and cadmium
- Temperature range: -50°C(-58°F) to 105°C(221°F)

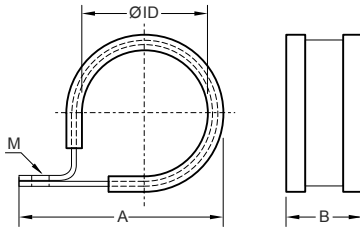

NW
CC-12
SERIES

Specifications are subject to change without notice

Order No.	Fits to	A		B		ØID		M
	NW	mm	in	mm	in	mm	in	mm
CC-07	7	25.0	0.98	13.0	0.51	9.0	0.35	4.0
CC-10	10	26.0	1.02	13.0	0.51	12.0	0.47	4.0
CC-12	12	31.0	1.22	13.0	0.51	14.0	0.55	4.0
CC-14	14	34.0	1.34	15.0	0.59	17.5	0.69	4.0
CC-17	17	40.0	1.57	17.0	0.67	20.0	0.79	5.0
CC-20	20	42.0	1.65	16.5	0.65	21.0	0.83	5.0
CC-23	23	50.0	1.97	17.0	0.67	26.0	1.02	5.0
CC-24	24	47.0	1.85	16.5	0.65	26.0	1.02	5.0
CC-29	29	65.0	2.56	21.0	0.83	32.0	1.26	6.0
CC-36	36	70.0	2.76	21.0	0.83	40.0	1.57	6.0
CC-48	48	87.0	3.43	21.0	0.83	52.0	2.05	6.0

CU Galvanized Steel Tube Clamp



- Galvanized steel according to DIN 3016
- Elastometer is free from halogens and cadmium
- Temperature range: -50°C(-58°F) to 105°C(221°F)

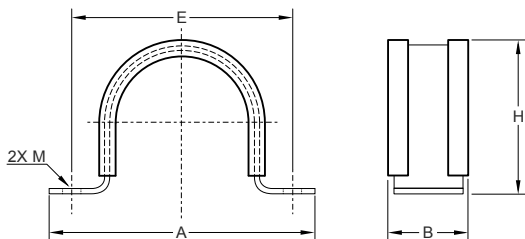

NW
CU-12
SERIES

Specifications are subject to change without notice

Order No.	Fits to	A		B		H		E		M
	NW	mm	in	mm	in	mm	in	mm	in	mm
CU-36	36	80.0	3.15	19.0	0.75	48.0	1.89	65.0	2.56	6.0
CU-48	48	94.0	3.70	19.0	0.75	58.0	2.28	78.0	3.07	6.0
CU-56	56	118.0	4.65	24.0	0.94	72.0	2.83	98.0	3.86	8.0
CU-70	70	130.0	5.12	24.0	0.94	85.0	3.35	110.0	4.33	8.0
CU-95	95	156.0	6.14	24.0	0.94	110.0	4.33	136.0	5.35	8.0
CU-125	125	200.0	7.87	24.0	0.94	152.0	5.98	180	7.09	8.0



- High-grade formulated polyamide
- Self-extinguishing, free from halogens and cadmium
- Excellent impact strength
- Temperature range: -40°C(-40°F) to 105°C(221°F)
- Short-term to 160°C(320°F)
- Content of delivery: Protection sleeve with assembling screws

ROBOTIC NW
KR-AS-56
 COLOUR MATERIAL SERIES TYPE

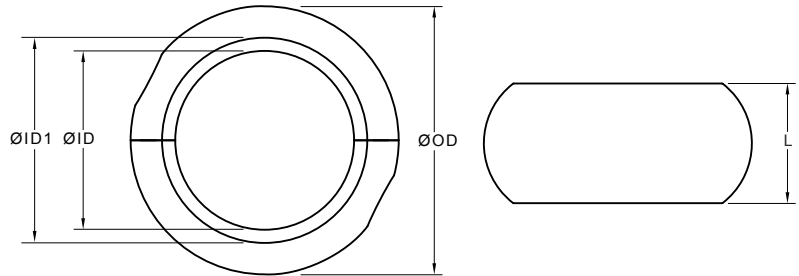

Specifications are subject to change without notice

ROBOTIC
LINE

Order No.	Fits to	ØID		ØID 1		ØOD		L	
	NW	mm	in	mm	in	mm	in	mm	in
KR-AS-23	23	24.0	0.94	28.5	1.12	49.0	1.93	34.0	1.34
KR-AS-29	29	30.0	1.18	34.5	1.36	54.5	2.15	37.0	1.46
KR-AS-36	36	38.5	1.52	43.0	1.69	63.0	2.48	37.0	1.46
KR-AS-48	48	49.5	1.95	55.0	2.17	75.0	2.95	39.0	1.54
KR-AS-56	56	61.0	2.40	67.0	2.64	91.5	3.60	41.0	1.61
KR-AS-70	70	75.0	2.95	80.0	3.15	105.0	4.13	45.0	1.77

KRIS Conduit Internal Support Sleeve



- To be used with LHR coarse profile type of conduit
- High-grade formulated Nylon 6.6
- Self-extinguishing, free from halogens and cadmium
- Excellent impact strength
- Temperature range: -40°C(-40°F) to 105°C(221°F)
- Short-term to 160°C(320°F)

ROBOTIC NW
KR-IS-56
 COLOUR MATERIAL SERIES TYPE

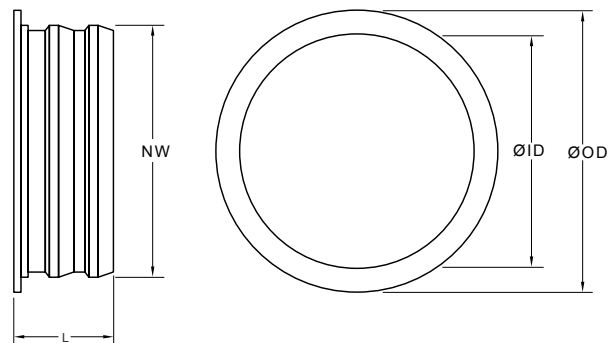

Specifications are subject to change without notice

Order No.	Fits to	ØID		ØOD		L	
	NW	mm	in	mm	in	mm	in
KR-IS-48	48	44.0	1.73	51.0	2.01	18.0	0.71
KR-IS-56	56	53.0	2.09	67.0	2.64	21.0	0.83
KR-IS-70	70	63.0	2.48	80.0	3.15	23.0	0.91



- High-grade formulated polyamide
- Self-extinguishing, free from halogens and cadmium
- Excellent impact strength
- Temperature range: -40°C(-40°F) to 105°C(221°F)
- Short-term to 160°C(320°F)

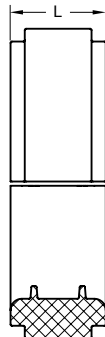
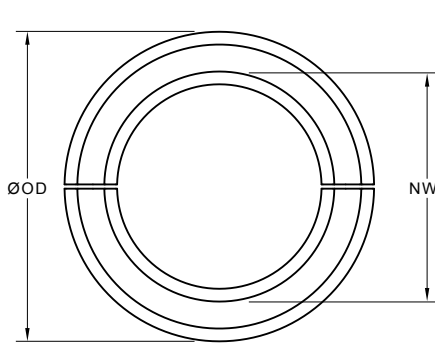
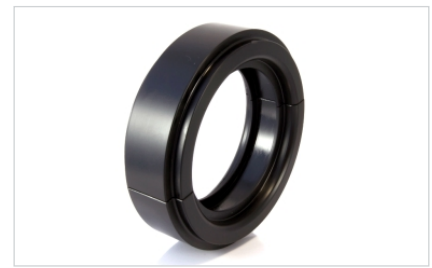

SR
Strain Relief / Reducer



SS
Slide / Reducer

ROBOTIC NW
KR-SR-5629
 COLOUR MATERIAL SERIES TYPE CONDUIT NW

Specifications are subject to change without notice

Order No.	Order No.	To be used with	Fits to		ØOD		L	
			NW		mm	in	mm	in
KR-SR-5629	KR-SS-5629	KR-C-56	29		85.5	3.37	29.5	1.16
KR-SR-5636	KR-SS-5636	KR-C-56	36		85.5	3.37	29.5	1.16
KR-SR-5648	KR-SS-5648	KR-C-56	48		85.5	3.37	29.5	1.16

ROBOTIC LINE

KRSC Grommet Strain Relief Insert



- High-grade formulated polyamide
- Self-extinguishing, free from halogens and cadmium
- Excellent impact strength
- Temperature range: -40°C(-40°F) to 105°C(221°F)
- Short-term to 160°C(320°F)
- For automation grommets RG

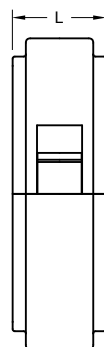
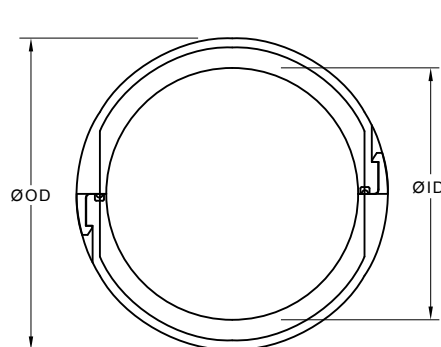

ROBOTIC NW
KR-SC-56
 COLOUR MATERIAL SERIES TYPE

Specifications are subject to change without notice

Order No.	Fits to	ØOD		ØID		L	
	NW	mm	in	mm	in	mm	in
KR-SC-56	56	68.3	2.69	55.3	2.18	20.6	0.81
KR-SC-70	70	82.0	3.23	69.0	2.72	20.6	0.81



- High-grade formulated polyamide
- Self-extinguishing, free from halogens and cadmium
- Excellent impact strength
- Temperature range: -40°C(-40°F) to 105°C(221°F)
- Short-term to 160°C(320°F)

ROBOTIC
KR-SRC-70
NW
COLOUR MATERIAL SERIES TYPE

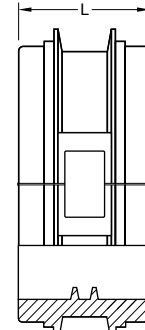
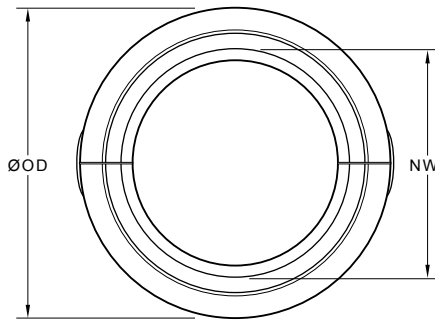

SR
Strain Relief

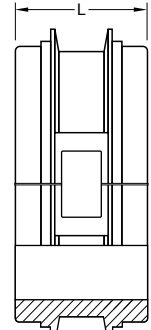

SS
Slide

Specifications are subject to change without notice

ROBOTIC
LINE

Order No.	Order No.	To be used with	Fits to	ØOD		L	
			NW	mm	in	mm	in
KR-SRC-56	KR-SSC-56	KR-C-56	56	86.0	3.39	43.0	1.69
KR-SRC-70	KR-SSC-70	KR-C-70	70	104.0	4.09	44.0	1.73

SWI-BASE-23 Swivel Base for Tube Clamp



- Black anodized aluminum
- Free from halogens and cadmium
- Excellent impact strength

Dimensions are in Millimeters

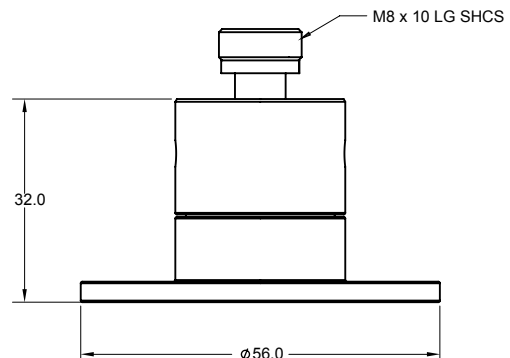
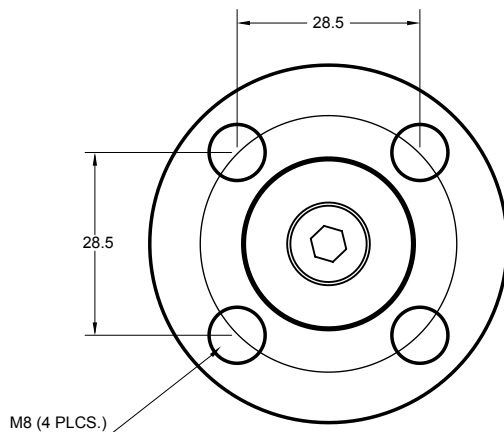



- High-grade formulated polyamide
- Self-extinguishing, free from halogens and cadmium
- Excellent impact strength
- Temperature range: -40°C(-40°F) to 105°C(221°F)
- Short-term to 160°C(320°F)

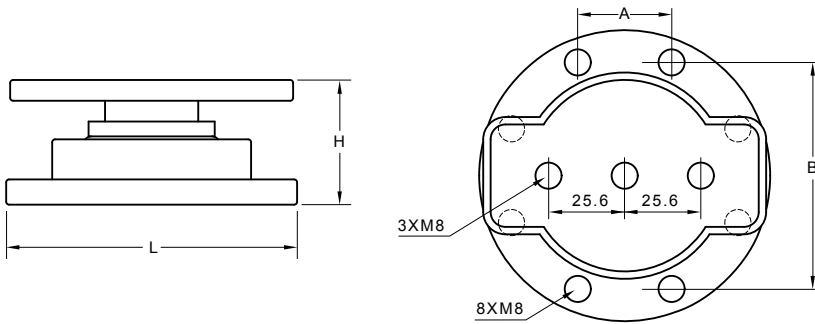

ROBOTIC NW
KR-SB-5670
 COLOUR SÉRIE
 MATERIAL TYPE NW

Specifications are subject to change without notice

Order No.	Fits to	A		B		L		H	
	NW	mm	in	mm	in	mm	in	mm	in
KR-SB-5670	56 / 70	31.6	1.24	76.3	3.00	98.0	3.86	42.0	1.65

ROBOTIC LINE

SWI-BASE ROBOT2 Swivel Base for KR-C Clamp



- Black anodized aluminum
- Free from halogens and cadmium
- Excellent impact strength



Dimensions are in Millimeters

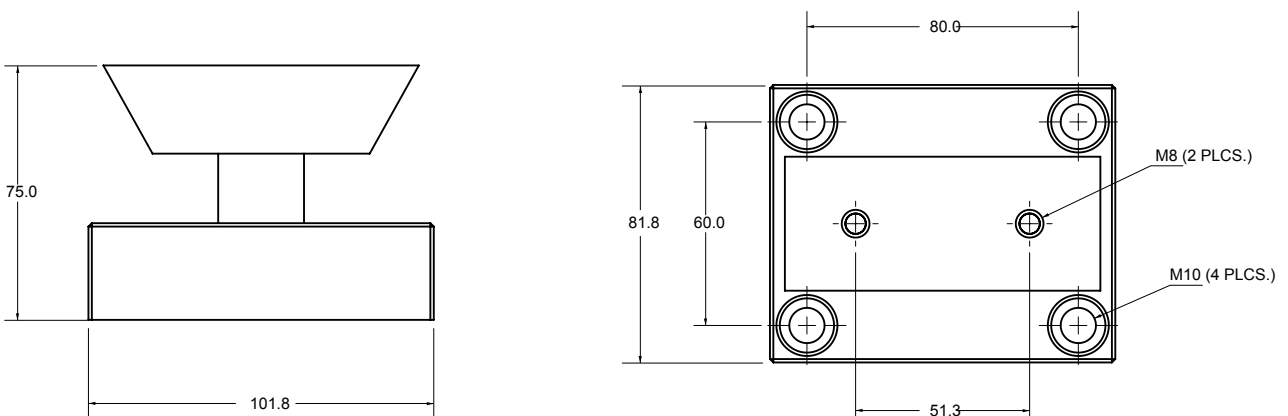



- High-grade formulated polyamide
- Self-extinguishing, free from halogens and cadmium
- Excellent impact strength
- Temperature range: -40°C(-40°F) to 105°C(221°F)
- Short-term to 160°C(320°F)
- Content of delivery: Ball Joint with assembling screws

ROBOTIC NW
KR-JS-56
COLOUR MATERIAL SÉRIES TYPE

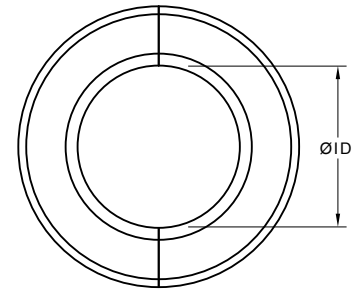
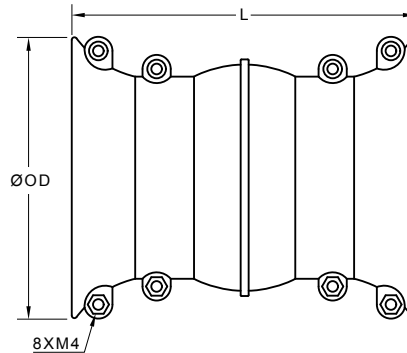

Specifications are subject to change without notice

ROBOTIC LINE

Order No.	Fits to	ØOD		ØID		L	
	NW	mm	in	mm	in	mm	in
KR-JS-56	56	110.0	4.33	61.0	2.40	130.0	5.12
KR-JS-70	70	124.0	4.88	75.0	2.95	154.0	6.06

KRJT Ball Joint Termination



- High-grade formulated polyamide
- Self-extinguishing, free from halogens and cadmium
- Excellent impact strength
- Temperature range: -40°C(-40°F) to 105°C(221°F)
- Short-term to 160°C(320°F)
- Content of delivery: Ball Joint with assembling screws

ROBOTIC NW
KR-JT-56
COLOUR MATERIAL SÉRIES TYPE

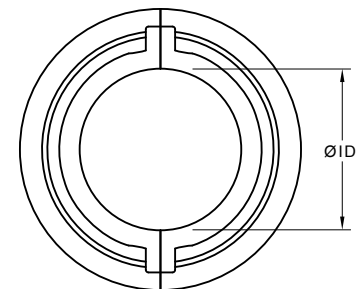
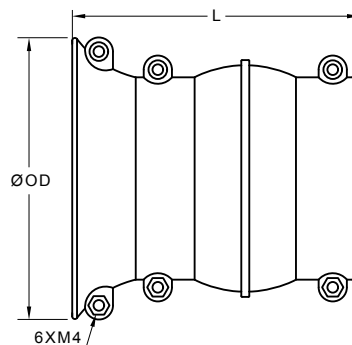

Specifications are subject to change without notice

Order No.	Fits to	ØOD		ØID		L	
	NW	mm	in	mm	in	mm	in
KR-JT-56	56	105.6	4.16	60.7	2.39	108.2	4.26
KR-JT-70	70	118.4	4.66	74.4	2.93	132.0	5.20



- High-grade formulated polyamide
- Self-extinguishing, free from halogens and cadmium
- Excellent impact strength
- Temperature range: -40°C(-40°F) to 105°C(221°F)
- Short-term to 160°C(320°F)

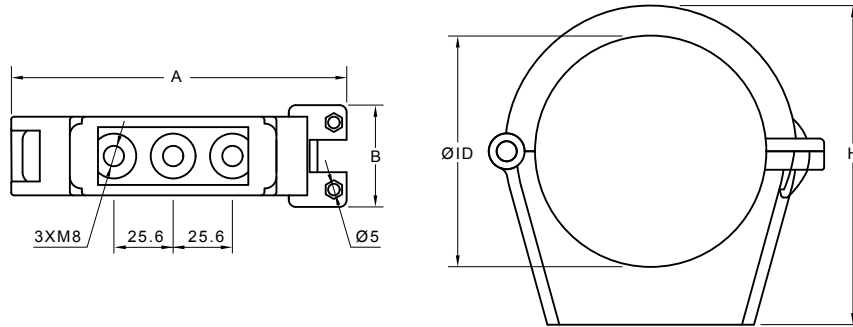

ROBOTIC NW
KR-C-56
 COLOUR MATERIAL SERIES TYPE

Specifications are subject to change without notice

Order No.	Fits to	A		B		H		ØID	
	NW	mm	in	mm	in	mm	in	mm	in
KR-C-56	56	120.3	4.74	34.0	1.34	115.3	4.54	79.5	3.13
KR-C-70	70	145.0	5.71	44.0	1.73	138.0	5.43	100.0	3.94

ROBOTIC LINE

NGP-95-1-X1 Automation Tube Clamp



- Black anodized aluminum
- Free from halogens and cadmium
- Excellent impact strength



Dimensions are in Millimeters

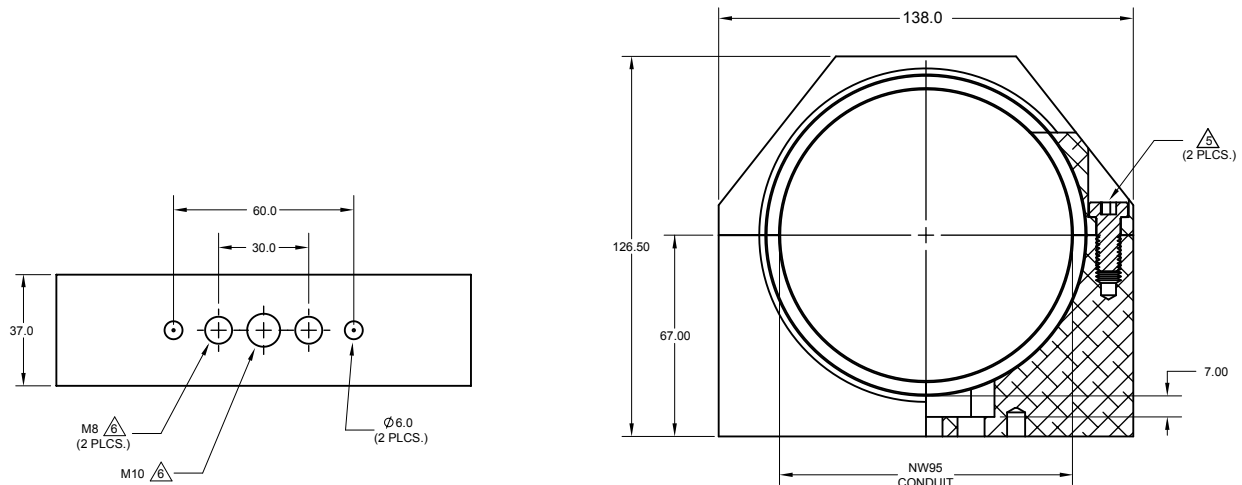

TEARLEX

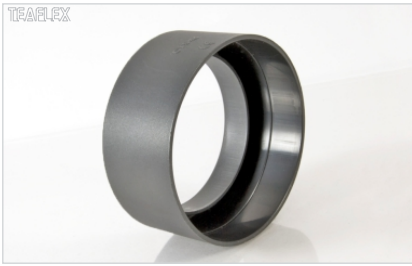

- High-grade formulated polyamide
- Self-extinguishing, free from halogens and cadmium
- Excellent impact strength
- Temperature range: -40°C(-40°F) to 105°C(221°F)
- Short-term to 160°C(320°F)

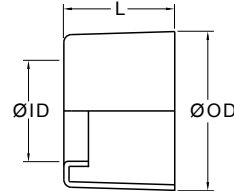
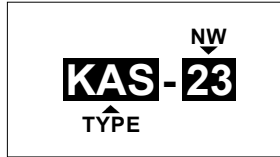

Specifications are subject to change without notice

Order No.	Fits to	ØID		ØOD		L	
	NW	mm	in	mm	in	mm	in
KAS-07	07	4.0	0.16	12.8	0.50	15.4	0.61
KAS-10	10	6.9	0.27	15.7	0.62	15.4	0.61
KAS-12	12	9.5	0.37	18.5	0.73	18.4	0.72
KAS-17	17	12.9	0.51	24.0	0.94	20.4	0.80
KAS-23	23	19.2	0.76	31.7	1.25	21.4	0.84
KAS-29	29	24.7	0.97	37.8	1.49	22.4	0.88
KAS-36	36	32.8	1.29	45.7	1.80	24.4	0.96
KAS-48	48	44.3	1.74	57.8	2.28	25.4	1.00
KAS-56	56	53.5	2.11	70.4	2.77	26.4	1.04

AC Sealing Caps

TEARLEX



TEARLEX



- Inlet protection up to IP68 static and IP67 dynamic
- Specially modified polyester-elastomer
- Self-extinguishing, free from halogens and cadmium
- Temperature range: -40°C(-40°F) to 105°C(221°F)
- Short-term to 160°C(320°F)

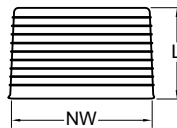
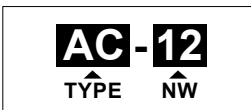

FROM NW07 TO NW48



FROM NW56 TO NW95

Specifications are subject to change without notice

Order No.	Fits to	L	
	NW	mm	in
AC-07	07	9.0	0.35
AC-10	10	9.0	0.35
AC-12	12	12.0	0.47
AC-17	17	12.0	0.47
AC-23	23	13.0	0.51
AC-29	29	14.5	0.57
AC-36	36	17.5	0.69
AC-48	48	17.5	0.69
AC-56	56	21.5	0.85
AC-70	70	21.5	0.85
AC-95	95	21.5	0.85



- Nitrile rubber
- Temperature range: - 40°C(-40°F) to 105°C(221°F)

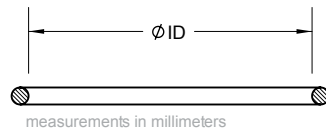

Specifications are subject to change without notice

Order Number	Order Number	Order Number	Order Number	Order Number	Order Number
OR 8.00x 1.00	OR19.00x1.50	OR28.00x2.00	OR36.00x3.00	OR46.00x2.70	OR58.00x2.00
OR 8.00x 1.80	OR19.00x2.00	OR28.00x2.50	OR37.00x2.50	OR47.00x2.00	OR59.00x1.50
OR 9.00x 1.50	OR19.05x2.80	OR28.30x2.62	OR37.00x3.00	OR47.00x2.50	OR59.00x2.00
OR 9.00x 2.00	OR20.00x1.00	OR29.00x2.00	OR37.77x2.62	OR48.00x1.50	OR60.05x1.78
OR 9.50x 2.50	OR20.00x1.30	OR29.00x1.50	OR38.00x2.00	OR48.00x2.00	OR61.00x1.80
OR10.00x1.50	OR20.00x1.50	OR29.00x1.70	OR38.00x2.50	OR48.00x3.00	OR61.00x2.00
OR12.00x1.00	OR20.00x1.80	OR30.00x1.00	OR38.00x3.00	OR48.00x4.00	OR63.00x2.00
OR12.50x1.00	OR20.00x2.00	OR30.00x1.50	OR39.00x1.50	OR49.50x1.50	OR63.00x3.00
OR12.70x2.00	OR20.00x2.50	OR30.00x2.00	OR39.00x2.00	OR50.00x2.50	OR63.20x1.78
OR13.00x1.50	OR21.00x1.00	OR31.00x1.00	OR39.00x2.50	OR50.00x2.70	OR65.00x3.00
OR13.00x1.70	OR21.00x1.50	OR31.00x1.50	OR39.00x3.00	OR50.47x2.62	OR67.95x2.62
OR13.00x1.75	OR21.00x1.70	OR31.00x1.70	OR39.34x2.62	OR51.00x1.50	OR68.00x2.50
OR13.00x2.00	OR21.00x2.00	OR31.00x2.00	OR40.00x1.50	OR51.00x1.80	OR68.00x3.00
OR13.00x2.50	OR21.95x1.78	OR31.47x1.78	OR40.00x2.00	OR51.00x2.00	OR70.00x2.50
OR14.00x1.00	OR22.00x1.50	OR31.50x1.70	OR41.00x1.60	OR51.00x2.50	OR72.00x3.00
OR14.00x1.50	OR22.00x2.00	OR32.00x1.50	OR41.00x1.80	OR52.00x1.90	OR72.00x4.00
OR14.00x1.85	OR22.00x2.50	OR32.00x1.70	OR41.00x2.50	OR52.00x2.00	OR75.87x2.62
OR14.00x2.00	OR23.00x1.00	OR32.00x2.00	OR42.00x1.00	OR52.00x2.50	OR82.00x4.00
OR15.00x1.00	OR23.00x1.50	OR32.00x2.50	OR42.00x1.50	OR53.00x1.50	OR82.22x2.62
OR16.00x1.50	OR23.00x1.80	OR33.00x1.50	OR42.00x2.00	OR53.00x1.80	OR90.00x2.50
OR16.00x2.00	OR24.00x1.00	OR33.00x2.00	OR42.00x2.50	OR53.00x2.00	OR110.00x3.00
OR16.50x1.00	OR24.00x1.50	OR33.00x2.50	OR43.00x2.00	OR53.64x2.62	OR133.00x7.00
OR16.50x1.50	OR24.00x1.70	OR33.05x1.78	OR44.00x1.70	OR54.00x2.00	OR150.00x3.00
OR16.00x1.70	OR24.00x2.00	OR33.65x1.70	OR44.00x2.00	OR54.00x2.50	
OR16.00x1.80	OR25.00x1.50	OR34.05x1.78	OR44.00x2.50	OR54.00x3.00	
OR16.00x2.00	OR25.00x1.80	OR34.65x1.78	OR45.00x1.00	OR55.00x2.00	
OR17.00x1.00	OR25.00x2.00	OR35.00x1.00	OR45.00x1.50	OR55.00x2.50	
OR17.00x1.50	OR26.00x2.00	OR35.00x1.50	OR45.00x2.00	OR56.00x1.50	
OR17.00x2.00	OR27.00x1.50	OR35.00x2.00	OR45.00x2.50	OR56.00x1.80	
OR17.00x2.50	OR27.00x2.00	OR35.00x2.50	OR45.00x3.00	OR56.00x2.00	
OR18.00x1.00	OR27.00x2.50	OR36.00x1.00	OR46.00x1.00	OR56.82x2.62	
OR18.00x1.50	OR28.00x1.00	OR36.00x1.50	OR46.00x1.50	OR57.00x2.00	
OR18.00x2.00	OR28.00x1.50	OR36.00x2.00	OR46.00x2.50	OR57.00x2.50	

TEAFLEX



- NBR reinforced with aramide fibres (asbestos-free)
- Provides up to IP68 Ingress protection
- Temperature range: -45°C(-49°F) to 200°C(392°F);
- Short-term to 400°C(752°F)

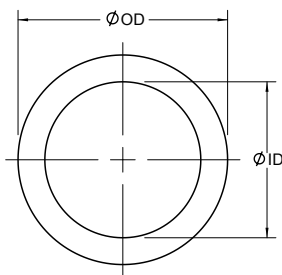

Specifications are subject to change without notice

Order No.	Thread Metric	ØOD		ØID		H	
		mm	in	mm	in	mm	in
G8-AG-M12	M12x1.5	18.0	1.02	13.0	0.81	2.0	0.08
G8-AG-M16	M16x1.5	22.0	0.87	16.3	0.64	2.0	0.08
G8-AG-M20	M20x1.5	26.0	1.02	20.5	0.81	2.0	0.08
G8-AG-M25	M25x1.5	32.0	1.26	25.3	1.00	2.0	0.08
G8-AG-M32	M32x1.5	39.0	1.54	32.3	1.27	2.0	0.08
G8-AG-M40	M40x1.5	50.0	1.97	40.3	1.59	2.0	0.08
G8-AG-M50	M50x1.5	60.0	2.36	50.3	1.98	2.0	0.08
G8-AG-M63	M63x1.5	73.0	2.87	63.3	2.49	2.0	0.08

Order No.	Thread NPT	ØOD		ØID		H	
		mm	in	mm	in	mm	in
G8-AG-N00	1/4	18.0	0.71	13.3	0.52	2.0	0.08
G8-AG-N01	3/8	23.0	0.91	17.0	0.67	2.0	0.08
G8-AG-N02	1/2	28.3	1.11	21.8	0.86	2.0	0.08
G8-AG-N04	3/4	37.2	1.46	26.8	1.06	2.0	0.08
G8-AG-N06	1	44.3	1.74	34.0	1.34	2.0	0.08
G8-AG-N07	1-1/4	52.0	2.05	42.0	1.65	2.0	0.08
G8-AG-N08	1-1/2	58.0	2.28	48.0	1.89	2.0	0.08
G8-AG-N09	2	70.0	2.76	61.2	2.41	2.0	0.08

Order No.	Thread PG	ØOD		ØID		H	
		mm	in	mm	in	mm	in
G8-AG-P07	7	18.0	0.71	13.3	0.52	2.00	0.08
G8-AG-P09	9	20.0	0.79	15.2	0.60	2.00	0.08
G8-AG-P11	11	23.0	0.91	19.0	0.75	2.00	0.08
G8-AG-P13	13.5	26.0	1.02	20.5	0.81	2.00	0.08
G8-AG-P16	16	28.0	1.10	22.7	0.89	2.00	0.08
G8-AG-P21	21	35.0	1.38	28.5	1.12	2.00	0.08
G8-AG-P29	29	44.5	1.75	37.2	1.46	2.00	0.08
G8-AG-P36	36	58.0	2.28	48.0	1.89	2.00	0.08
G8-AG-P42	42	63.0	2.48	54.3	2.14	2.00	0.08



• To be used with all Grip Lock Fittings from NW07 to NW48

FROM NW
OT-0748
 SERIES TO NW

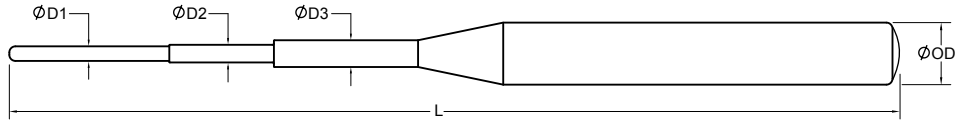

Specifications are subject to change without notice

Order No.	L		ØOD		ØD1		ØD2		ØD3	
	mm	in	mm	in	mm	in	mm	in	mm	in
OT-0748	143.0	5.63	10.0	0.39	2.4	0.09	2.8	0.11	4.4	0.17

MGL-CUT Grip Lock Conduit Cutting Tool

- For cutting reinforced flexible conduit from NW07 to NW48
- Light weight and compact in design

SERIES TO NW
MGL-CUT-0729
 PRODUCT FROM NW
 LINE



Specifications are subject to change without notice

Order No.	OL		Weight	Cutting Capacity Ø	
	mm	in		mm	in
MGL-CUT-0729	220.0	8.66	145g	38.0	1.50
MGL-CUT-2348	250.0	9.84	425g	55.0	2.17

ST Split Conduit Insertion Tool



- Specially modified Polyamide
- Self-extinguishing, free from halogens and cadmium
- Temperature range: -40°C(-40°F) to 105°C(221°F)
- Short-term to 160°C(320°F)



Specifications are subject to change without notice

Measurements in millimeters

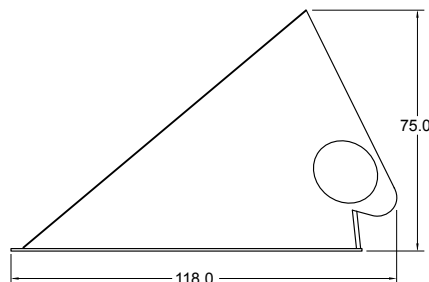
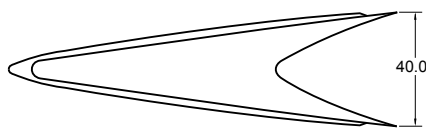

FROM TO
STH-0734
 TYPE NW NW
 W/ HOLE

FROM TO
STD-0734
 TYPE NW NW
 W/ HANDLE



- Polyamide glass fibre reinforced
- Temperature range: -40°C(-40°F) to 105°C(221°F)
- Short-term to 150°C(302°F)

THREAD SIZE
KLN - M16
TYPE THREAD TYPE

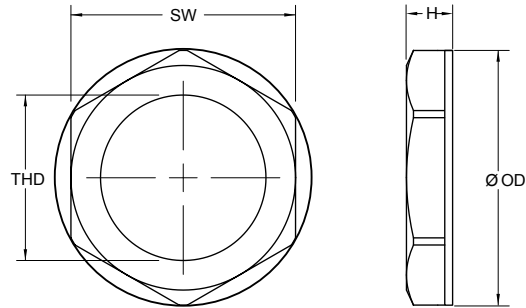

Specifications are subject to change without notice

**METRIC
THREAD**

Order No.	THD Metric	SW		ØOD		H	
		mm	in	mm	in	mm	in
KLN-M12	M12x1.5	17.0	0.67	19.0	0.75	5.0	0.20
KLN-M16	M16x1.5	22.0	0.87	24.0	0.94	5.0	0.20
KLN-M20	M20x1.5	26.0	1.02	29.0	1.14	6.0	0.24
KLN-M25	M25x1.5	32.0	1.26	35.0	1.38	7.0	0.28
KLN-M32	M32x1.5	40.0	1.57	44.0	1.73	7.0	0.28
KLN-M40	M40x1.5	50.0	1.97	54.0	2.13	7.0	0.28
KLN-M50	M50x1.5	60.0	2.36	67.0	2.64	8.0	0.31
KLN-M63	M63x1.5	73.0	2.87	81.0	3.19	8.0	0.31

**PG
THREAD**

Order No.	THD PG	SW		ØOD		H	
		mm	in	mm	in	mm	in
KLN-P07	7	19.0	0.75	21.0	0.83	5.0	0.20
KLN-P09	9	22.0	0.87	24.0	0.94	5.0	0.20
KLN-P11	11	24.0	0.94	26.0	1.02	5.0	0.20
KLN-P13	13.5	27.0	1.06	29.0	1.14	6.0	0.24
KLN-P16	16	30.0	1.18	33.0	1.30	6.0	0.24
KLN-P21	21	36.0	1.42	39.0	1.54	7.0	0.28
KLN-P29	29	46.0	1.81	50.0	1.97	7.0	0.28
KLN-P36	36	60.0	2.36	66.0	2.60	8.0	0.31
KLN-P48	48	70.0	2.76	78.0	3.07	8.0	0.31

**NPT
THREAD**

Order No.	THD NPT	SW		ØOD		H	
		mm	in	mm	in	mm	in
KLN-N00	1/4	19.0	0.75	21.0	0.83	5.0	0.20
KLN-N01	3/8	22.0	0.87	24.0	0.94	5.0	0.20
KLN-N02	1/2	27.0	1.06	30.0	1.18	6.0	0.24
KLN-N04	3/4	32.0	1.26	35.0	1.38	7.0	0.28
KLN-N06	1	39.0	1.54	42.5	1.67	7.0	0.28
KLN-N07	1-1/4	52.0	2.05	57.0	2.24	8.0	0.31
KLN-N08	1-1/2	60.0	2.36	66.0	2.60	8.0	0.31
KLN-N09	2	70.0	2.76	78.0	3.07	8.0	0.31



- Nickel-plated brass
- Temperature range: -60°C(-76°F) to 200°C(392°F)

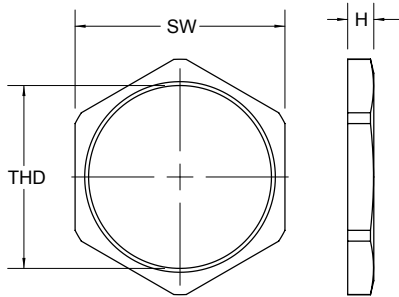

THREAD SIZE
BLN - M16
TYPE THREAD TYPE

Specifications are subject to change without notice

Order No.	THD Metric	SW		H	
		mm	in	mm	in
BLN-M12	M12x1.5	15.0	0.59	2.8	0.11
BLN-M16	M16x1.5	19.0	0.75	4.0	0.16
BLN-M20	M20x1.5	24.0	0.94	5.0	0.20
BLN-M25	M25x1.5	29.0	1.14	5.0	0.20
BLN-M32	M32x1.5	36.0	1.42	5.0	0.20
BLN-M40	M40x1.5	45.0	1.77	6.0	0.24
BLN-M50	M50x1.5	54.0	2.13	6.0	0.24
BLN-M63	M63x1.5	66.0	2.60	10.0	0.39

METRIC
THREAD

Order No.	THD PG	SW		H	
		mm	in	mm	in
BLN-P07	7	15.0	0.59	4.0	0.16
BLN-P09	9	19.0	0.75	4.0	0.16
BLN-P11	11	22.0	0.87	4.0	0.16
BLN-P13	13.5	24.0	0.94	4.0	0.16
BLN-P16	16	27.0	1.06	4.0	0.16
BLN-P21	21	32.0	1.26	5.0	0.20
BLN-P29	29	42.0	1.65	5.5	0.22
BLN-P36	36	52.0	2.05	5.5	0.22
BLN-P48	48	66.0	2.60	10.0	0.39

PG
THREAD

Order No.	THD NPT	SW		H	
		mm	in	mm	in
BLN-N00	1/4	15.0	0.59	4.0	0.16
BLN-N01	3/8	19.0	0.75	4.0	0.16
BLN-N02	1/2	24.0	0.94	5.0	0.20
BLN-N04	3/4	30.0	1.18	5.0	0.20
BLN-N06	1	38.0	1.50	5.5	0.22
BLN-N07	1-1/4	45.0	1.77	6.0	0.24
BLN-N08	1-1/2	52.0	2.05	6.0	0.24
BLN-N09	2	66.0	2.60	10.0	0.39

NPT
THREAD